

GS910 Series

GIGABIT ETHERNET UNMANAGED SWITCHES

AT-GS910/5

AT-GS910/5E

AT-GS910/8

AT-GS910/8E

AT-GS910/16

AT-GS910/24

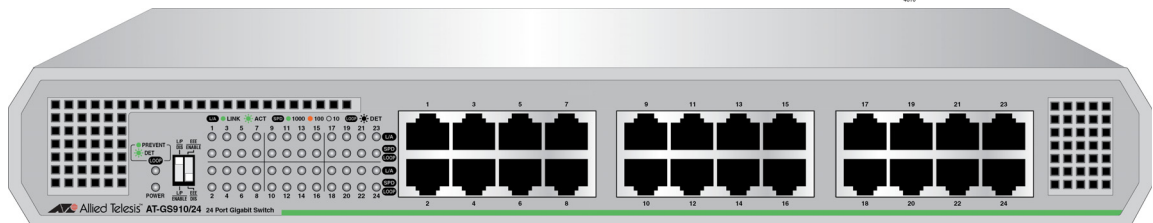
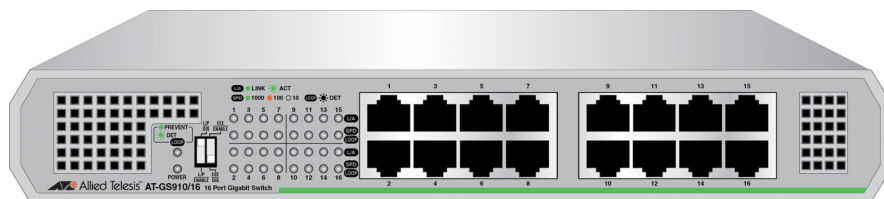
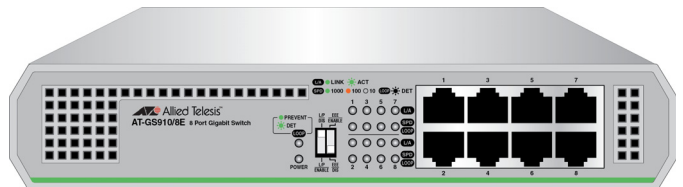
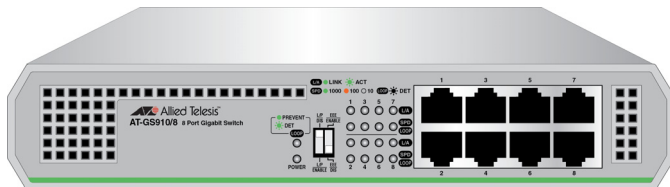
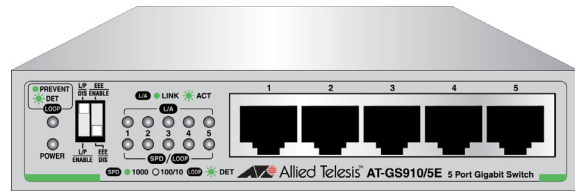
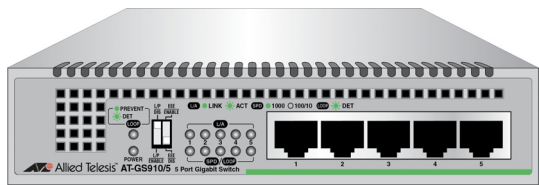

Installation and User's Guide

Copyright © 2016 Allied Telesis, Inc.

All rights reserved. No part of this publication may be reproduced without prior written permission from Allied Telesis, Inc.

Microsoft and Internet Explorer are registered trademarks of Microsoft Corporation. Netscape Navigator is a registered trademark of Netscape Communications Corporation. All other product names, company names, logos or other designations mentioned herein are trademarks or registered trademarks of their respective owners.

Allied Telesis, Inc. reserves the right to make changes in specifications and other information contained in this document without prior written notice. The information provided herein is subject to change without notice. In no event shall Allied Telesis, Inc. be liable for any incidental, special, indirect, or consequential damages whatsoever, including but not limited to lost profits, arising out of or related to this manual or the information contained herein, even if Allied Telesis, Inc. has been advised of, known, or should have known, the possibility of such damages.

Electrical Safety and Emissions Standards

This section contains the following:

- “US Federal Communications Commission”
- “Industry Canada”
- “Emissions, Immunity and Electrical Safety Standards” on page 4
- “Translated Safety Statements” on page 4

US Federal Communications Commission

Radiated Energy

Note

This equipment has been tested and found to comply with the limits for a Class A digital device pursuant to Part 15 of FCC Rules. These limits are designed to provide reasonable protection against harmful interference when the equipment is operated in a commercial environment. This equipment generates, uses, and can radiate radio frequency energy and, if not installed and used in accordance with this instruction manual, may cause harmful interference to radio communications. Operation of this equipment in a residential area is likely to cause harmful interference in which case the user will be required to correct the interference at his own expense.

Note

Modifications or changes not expressly approved of by the manufacturer or the FCC, can void your right to operate this equipment.

Industry Canada

Radiated Energy

This Class A digital apparatus complies with Canadian ICES-003.

Cet appareil numérique de la classe A est conforme à la norme NMB-003 du Canada.

Emissions, Immunity and Electrical Safety Standards

RFI Emissions FCC Class A, CISPR 22 Class A, CISPR 32 Class A, EN55022 Class A,
EN55032 Class A, VCCI, ICES-3(A)/NMB-3(A)



Warning

In a domestic environment this product may cause radio interference in which case the user may be required to take adequate measures. ⚡ E84

EMC (Immunity) EN55024, EN61000-3-2, EN61000-3-3

Electrical Safety UL60950-1 (CUL_{US}), UL-CB, UL-EU

Translated Safety Statements

Important: The ⚡ indicates that translations of the safety statement are available in the PDF document ***Translated Safety Statements*** posted on the Allied Telesis website at ***alliedtelesis.com/support***.

Contents

Preface	7
Safety Symbols Used in this Document	8
Contacting Allied Telesis	9
Chapter 1: Product Description	11
Overview	12
AT-GS910/5 Switch	12
AT-GS910/5E Switch	13
AT-GS910/8 Switch	14
AT-GS910/8E Switch	14
AT-GS910/16 Switch	15
AT-GS910/24 Switch	16
Wall and Rack Mount Brackets	16
LEDs	17
10/100/1000 Base-TX Twisted Pair Ports	18
Power Connector	19
Key Features	20
Ethernet Switching Basics	21
Duplex Mode	21
Store-and- Forward	21
Backpressure and Flow Control	21
Loop Prevention	23
Examples with Multiple Loop Prevention Switches	23
Examples with Loop Prevention and Regular Switches	24
Examples within a Loop Prevention Switch	25
Guidelines for Loop Prevention	26
Enabling Loop Protection	26
Disabling Loop Protection	26
Energy Efficiency Ethernet (EEE)	27
Chapter 2: Installation	29
Reviewing Safety Precautions	30
Selecting a Site for the Switch	32
Planning the Installation	33
Unpacking the Switch	34
Installing the Switch on a Table or Desktop	36
Installing the Switch on a Wall	37
Guidelines for Installing the Switch on a Wall	37
What to Prepare for Installation with Brackets	39
Installing the AT-GS910/5, AT-GS910/8, or AT-GS910/8E Switch on a Wall	39
Installing the AT-GS910/16 Switch on a Wall	39
Installing the AT-GS910/24 Switch on a Wall	41
Installing the Switch in an Equipment Rack	44
Guidelines for Installing the Switch in a Rack	44
What to Prepare for Installation in a Rack	44
Installing the AT-GS910/8 or AT-GS910/8E Switch in a Rack	44
Installing the AT-GS910/16 Switch in a Rack	44
Installing the AT-GS910/24 Switch in a Rack	46
Cabling the Switch	48
Powering On the Switch	49
Chapter 3: Installation Using the AT-BRKT-J23 Wall Mount Kit	51

Reviewing Safety Precautions	52
Unpacking the AT-BRKT-J23 Wall Mount Kit	53
Installing a Switch Using the AT-BRKT-J23 Wall Mount Kit	54
What to Prepare	54
Installing a Switch Using the Wall Mount Kit	54
Chapter 4: Installation Using the AT-RKMT-J08 Rack Mount Kit	57
Reviewing Safety Precautions	58
Unpacking the AT-RKMT-J08 Rack Mount Kit	59
Installing a Switch Using the AT-RKMT-J08 Rack Mount Kit	61
What to Prepare	61
Installing a Switch Using the Rack Mount Kit	61
Chapter 5: Troubleshooting	65
Appendix A: Technical Specifications	67
Physical Specifications	67
Environmental Specifications.....	67
Safety and Electromagnetic Emissions Certifications.....	68
Power Specifications	68
RJ-45 Twisted Pair Port Connectors	69

Preface

This manual is the installation and user's guide for the GS910 Series Gigabit Ethernet Unmanaged Switches. The switch models included in this manual are:

- ❑ AT-GS910/5
- ❑ AT-GS910/5E
- ❑ AT-GS910/8
- ❑ AT-GS910/8E
- ❑ AT-GS910/16
- ❑ AT-GS910/24

This Preface contains the following sections:

- ❑ "Safety Symbols Used in this Document" on page 8
- ❑ "Contacting Allied Telesis" on page 9

Safety Symbols Used in this Document

This document uses the following conventions:

Note

Notes provide additional information.



Caution

Cautions inform you that performing or omitting a specific action may result in equipment damage or loss of data.



Warning

Warnings inform you that performing or omitting a specific action may result in bodily injury.

Contacting Allied Telesis

If you need assistance with this product, you may contact Allied Telesis technical support by going to the Support & Services section of the Allied Telesis web site at **www.alliedtelesis.com/support**. You can find links for the following services on this page:

- ❑ 24/7 Online Support - Enter our interactive support center to search for answers to your questions in our knowledge database, check support tickets, learn about Return Merchandise Authorization (RMA), and contact Allied Telesis technical experts.
- ❑ USA and EMEA phone support - Select the phone number that best fits your location and customer type.
- ❑ Hardware warranty information - Learn about Allied Telesis warranties and register your product online.
- ❑ Replacement Services - Submit an RMA request via our interactive support center.
- ❑ Documentation - View the most recent installation guides, user guides, software release notes, white papers and data sheets for your product.
- ❑ Software Updates - Download the latest software releases for your product.

For sales or corporate contact information, go to **www.alliedtelesis.com/purchase** and select your region.

Chapter 1

Product Description

This chapter contains the follows sections:

- ❑ “Overview” on page 12
- ❑ “Key Features” on page 20
- ❑ “Ethernet Switching Basics” on page 21
- ❑ “Loop Prevention” on page 23
- ❑ “Energy Efficiency Ethernet (EEE)” on page 27

Overview

The GS910 Series Gigabit Ethernet Switch is an eco-friendly unmanaged Gigabit Ethernet switch with 10/100/1000 Mbps twisted-pair ports. The GS910 series switch provides a simple solution to integrate 10, 100, and 1000Mbps devices that exist in your network and expand the network to Gigabit speed.

The eco-friendly feature automatically saves power consumption on each port when the port has not established a link. In addition, the switch does not require software configuration or management.

The GS910 Series Gigabit Ethernet Switch includes the following models:

- “AT-GS910/5 Switch”
- “AT-GS910/5E Switch”
- “AT-GS910/8 Switch” on page 14
- “AT-GS910/8E Switch” on page 14
- “AT-GS910/16 Switch” on page 15
- “AT-GS910/24 Switch” on page 16

AT-GS910/5 Switch

The AT-GS910/5 switch has five 10/100/1000Base-TX twisted pair ports on the front panel as shown in Figure 1.

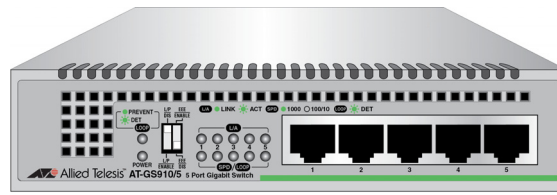

Figure 1. AT-GS910/5 Front Panel

The AT-GS910/5 switch has an internal power supply with a single AC power supply socket on the rear panel as shown in Figure 2.

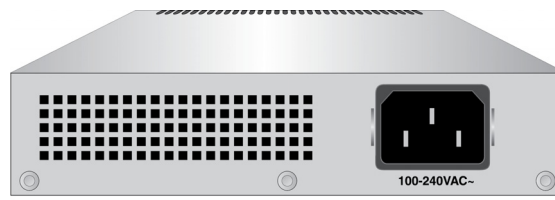

Figure 2. AT-GS910/5 Rear Panel

The AT-GS910/5 switch can be installed on a desktop or mounted on a wall. To mount the switch on a wall, use the AT-BRKT-J23 wall mount brackets.

Note

The AT-BRKT-J23 wall mount brackets are not included in the shipping box. You must purchase them separately.

**AT-GS910/5E
Switch**

The AT-GS910/5E switch has five 10/100/1000Base-TX twisted pair ports on the front panel as shown in Figure 3. The switch is installed on a desktop only.

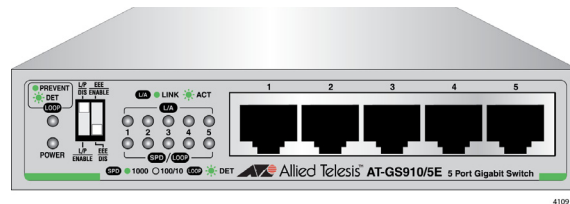

Figure 3. AT-GS910/5E Front Panel

The AT-GS910/5E switch has an external power supply with a single DC power supply socket on the rear panel as shown in Figure 4.



Figure 4. AT-GS910/5E Rear Panel

Note

The AT-GS910/5E power receptacle has a twist-and-lock barrel, which is locked by turning the power cord clockwise one-quarter turn.

AT-GS910/8 Switch

The AT-GS910/8 switch has eight 10/100/1000Base-TX twisted pair ports on the front panel as shown in Figure 5.

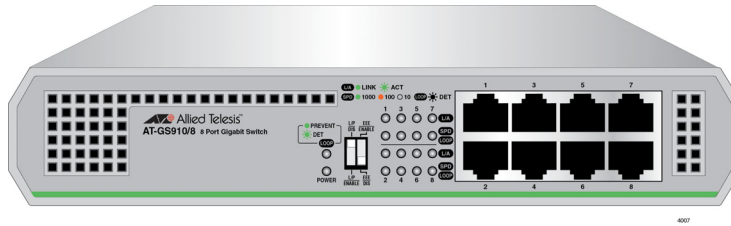

Figure 5. AT-GS910/8 Front Panel

The AT-GS910/8 switch has an internal power supply with a single AC power supply socket on the rear panel as shown in Figure 6.

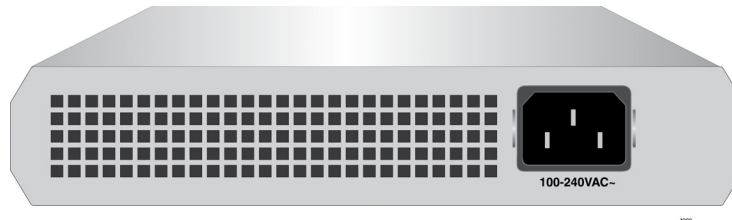

Figure 6. AT-GS910/8 Rear Panel

The AT-GS910/8 switch can be installed on a desktop, mounted on a wall, or mounted in a 19-inch equipment rack. To mount the switch on a wall, use the AT-BRKT-J23 wall mount brackets. To install the switch in an equipment rack, use the AT-RKMT-J08 rack mount brackets.

Note

The AT-BRKT-J23 and AT-RKMT-J08 brackets are not included in the shipping box. You must purchase them separately.

AT-GS910/8E Switch

The AT-GS910/8E switch has eight 10/100/1000Base-TX twisted pair ports on the front panel as shown in Figure 7. The switch is installed on a desktop only.

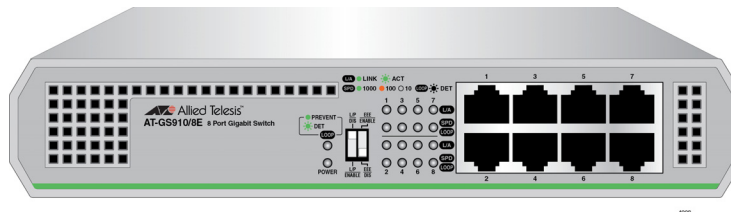

Figure 7. AT-GS910/8E Front Panel

The AT-GS910/8E switch has an external power supply with a single DC power supply socket on the rear panel as shown in Figure 8.

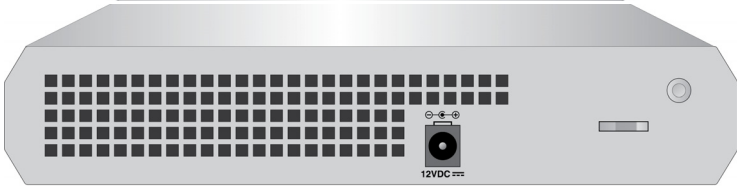

Figure 8. AT-GS910/8E Rear Panel

Note

The AT-GS910/8E power receptacle has a twist-and-lock barrel which is locked by turning the power cord clockwise one-quarter turn.

The AT-GS910/8E switch can be installed on a desktop, mounted on a wall, or mounted in a 19-inch equipment rack. To mount the switch on a wall, use the AT-BRKT-J23 wall mount brackets. To install the switch in an equipment rack, use the AT-RKMT-J08 rack mount brackets.

Note

The AT-BRKT-J23 and AT-RKMT-J08 brackets are not included in the shipping box. You must purchase them separately.

AT-GS910/16 Switch

The AT-GS910/16 switch has 16 10/100/1000Base-TX twisted pair ports on the front panel as shown in Figure 9.

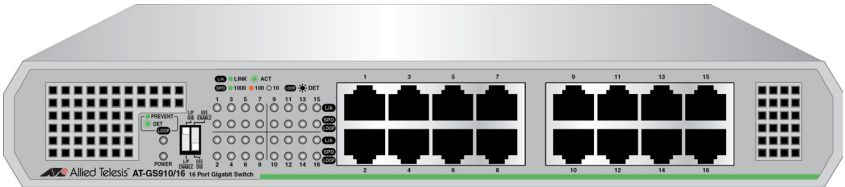

Figure 9. AT-GS910/16 Front Panel

The AT-GS910/16 switch has an internal power supply with a single AC power supply socket on the rear panel as shown in Figure 10.

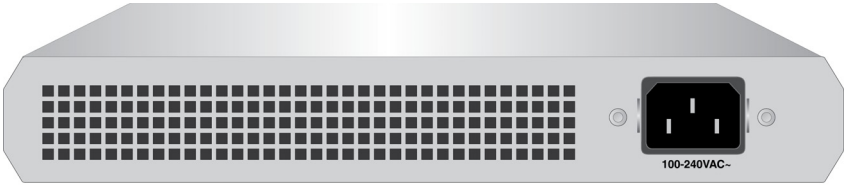

Figure 10. AT-GS910/16 Rear Panel

The AT-GS910/16 switch can be installed on a desktop, mounted on a wall, or mounted in a 19-inch equipment rack. To mount the switch on the wall or in an equipment rack, use the brackets that come with the switch.

AT-GS910/24 Switch

The AT-GS910/24 switch has 24 10/100/1000Base-TX twisted pair ports on the front panel as shown in Figure 11.

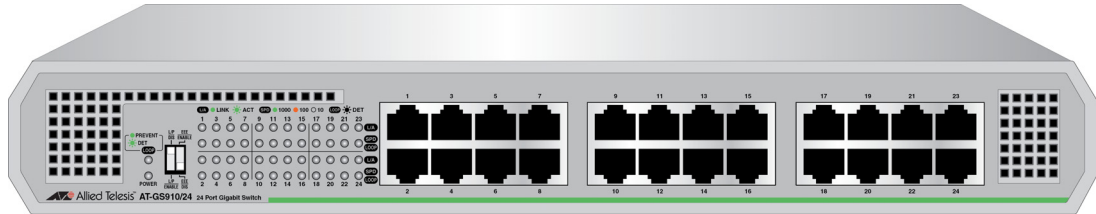

Figure 11. AT-GS910/24 Front Panel

The AT-GS910/24 switch has an internal power supply with a single AC power supply socket on the rear panel as shown in Figure 12.

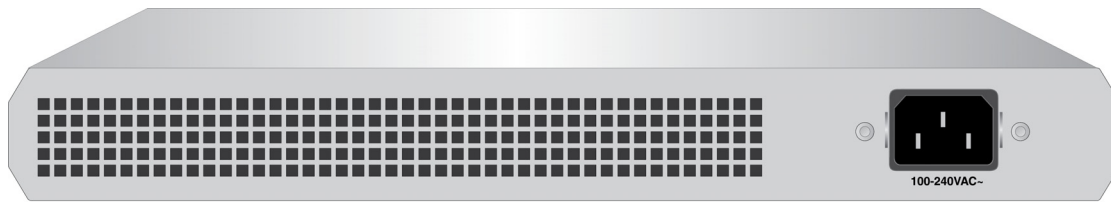

Figure 12. AT-GS910/24 Rear Panel

The AT-GS910/24 switch can be installed on a desktop, mounted on a wall, or mounted in a 19-inch equipment rack. To mount the switch on the wall or in an equipment rack, use the brackets that come with the switch.

Wall and Rack Mount Brackets

Table 1 shows brackets options for the GS910 series switches.

Table 1. Wall and Rack Mount Brackets

Model	Wall Mount	Rack Mount
AT-GS910/5	AT-BRKT-J23	N/A
AT-GS910/5E	N/A	N/A
AT-GS910/8	AT-BRKT-J23	AT-RKMT-J08
AT-GS910/8	AT-BRKT-J23	AT-RKMT-J08
AT-GS910/16	The brackets in the shipping box	The brackets in the shipping box
AT-GS910/24	The brackets in the shipping box	The brackets in the shipping box

LEDs The LEDs on the front panel of the GS910 series switch display status information.

LEDs for the AT-GS910/5 and AT-GS910/5 E Switches

Table 2 describes the LEDs on the AT-GS910/5 and AT-GS910/5E switches.

Table 2. LEDs for the AT-GS910/5 and AT-GS910/5E

LED	State	Description
POWER	Green	The switch is powered ON and operating normally.
	Off	The switch is not receiving power.
LOOP	Green	The Loop Prevention is enabled.
	Blinking Green	A loop has been detected and the switch blocks the looped port to stop the loop.
	Off	The Loop Prevention is disabled.
L/A	Green	A valid link is established on the port.
	Blinking Green	Frames are being transmitted/received on the port.
	Off	No link is established.
SPD/ LOOP	Green	The port is operating at 1000Mbps.
	Off	The port is operating at 10/100Mbps or no link is established.
	Blinking Green	A loop is detected while the port is operating at 10/100/1000Mbps. The switch blocks the looped port to stop the loop.

LEDs for the AT-GS910/8, AT-GS910/8E, AT-GS910/16, and AT-GS910/24 Switches

Table 3 on page 18 describes the LEDs on the AT-GS910/8, AT-GS910/8E, AT-GS910/16, and AT-GS910/24 switches.

Table 3. LEDs for the AT-GS910/8, AT-GS910/8E, AT-GS910/16, and AT-GS910/24 Switches

LED	State	Description
PWR	Green	The switch is powered ON and operating normally.
	Off	The switch is not receiving power.
LOOP	Green	The Loop Prevention is enabled.
	Blinking Green	A loop has been detected and the switch blocks the looped port to stop the loop.
	Off	The Loop Prevention is disabled.
L/A	Green	A valid link is established on the port.
	Blinking Green	Frames are being transmitted/received on the port.
	Off	No link is established.
SPD/ LOOP	Green	The port is operating at 1000Mbps.
	Amber	The port is operating at 100Mbps.
	Off	The port is operating at 10Mbps or no link is established.
	Blinking Green	A loop is detected while the port is operating at 1000Mbps. The switch blocks the looped port to stop the loop.
	Blinking Amber	A loop is detected while the port is operating at 10/100Mbps. The switch blocks the looped port to stop the loop.

10/100/1000 Base-TX Twisted Pair Ports

The GS910 series switch is equipped with multiple 10/100/1000Base-TX twisted pair ports

Connector

All twisted pair ports feature 8-pin RJ-45 connectors. For the port pinouts, see "RJ-45 Twisted Pair Port Connectors" on page 69.

Speed

The ports are 10Base-T, 100Base-TX, and 1000Base-T compliant and capable of 10 Mbps, 100 Mbps, and 1000 Mbps speeds. The ports are IEEE 802.3u Auto-Negotiation compliant. With Auto-Negotiation, the switch automatically matches the highest possible common speed between the switch port and its end-node.

For example, if an end-node is capable of only 10 Mbps, the switch sets the port connected to the end-node to 10 Mbps.

Duplex Mode

Each twisted pair port on the switch can operate in either half- or full-duplex mode. The twisted pair ports are IEEE 802.3u-compliant and automatically negotiate the duplex mode setting.

Note

In order for the switch to set the duplex mode for each port correctly, the end-nodes that you connect to the switch ports also need to be configured for Auto-Negotiation. Otherwise, a duplex mode mismatch can occur, affecting network performance. For further information, refer to “Duplex Mode” on page 21.

Cabling

Table 4 contains the cabling specifications for the twisted pair ports.

Table 4. Twisted Pair Cabling and Distances

Speed	Type of Cable	Maximum Operating Distance
10 Mbps	Two-pair Category 3 or better unshielded twisted pair cable	100 m (328 ft)
100 Mbps	Two-pair Category 5 unshielded twisted pair cable	100 m (328 ft)
1000 Mbps	Four-pair Category 5e unshielded twisted pair cable	100 m (328 ft)

Auto MDI/MDI-X

All of the twisted pair ports on the switch feature auto-MDI to automatically configure themselves as MDI or MDI-X when connected to an end-node. Consequently, you can use a straight-through twisted pair cable to connect any network device to a port.

Power Connector

The AT-GS910/5, AT-GS910/8, AT-GS910/16, and AT-GS910/24 switches have a single AC power supply socket on the back panel. The AT-GS910/5E and AT-GS910/8E switches have a single DC power supply socket on the back panel. Use the power adapter that came with the switch.

To power ON or OFF the switch, connect or disconnect the power cord.

Key Features

The GS910 series switches have the following key features:

- ❑ 10/100/1000 Mbps twisted pair ports with RJ-45 connectors
- ❑ IEEE802.3 compliant for 10Base-T
- ❑ IEEE802.3u compliant for 100Base-TX
- ❑ IEEE802.3ab compliant for 1000Base-T
- ❑ Auto-Negotiation (IEEE 802.3u-compliant) on all ports
- ❑ Auto MDI/MDI-X on all ports
- ❑ Store-and-forward switching method
- ❑ IEEE 802.3x flow control for full-duplex operation
- ❑ Back pressure flow control for half-duplex operation
- ❑ Head-of-line blocking
- ❑ Jumbo frames of 9216 bytes without frame loss for the AT-GS910/5, AT-GS910/5E, AT-GS910/8 and AT-GS910/8E switches
- ❑ Jumbo frames of 10K bytes without frame loss for the AT-GS910/16 and AT-GS910/24 switches
- ❑ Storage of up to 2K MAC addresses for the AT-GS910/5 and AT-GS910/5E switches
- ❑ Storage of up to 4K MAC addresses for the AT-GS910/8 and AT-GS910/8E switches
- ❑ Storage of up to 8K MAC addresses for the AT-GS910/16 and AT-GS910/24 switches
- ❑ BPDU protection from passing through
- ❑ EAPOL pass-through
- ❑ Power saving
- ❑ Loop Prevention that is enabled or disabled from the DIP switch on the front panel
- ❑ IEEE 802.3az Energy Efficient Ethernet that is enabled or disabled from the DIP switch on the front panel
- ❑ Diagnostic LEDs
- ❑ RoHS compliant
- ❑ 12VDC locking power connector for the AT-GS910/5E and AT-GS910/8E switches

Ethernet Switching Basics

An Ethernet switch interconnects network devices, such as workstations, printers, routers, and other Ethernet switches, so that they can communicate with each other by sending and receiving Ethernet frames.

Duplex Mode

Duplex mode refers to how an end node receives and transmits data. If an end node can receive or transmit data, but not both simultaneously, it is operating in half-duplex mode. If an end node can both receive and transmit data simultaneously, the end node is operating in full-duplex mode. As such an end node capable of operating in full-duplex can handle data much faster than an end node that can only operate in half-duplex mode.

The twisted pair ports on the GS910 series switch can operate in half- or full-duplex mode for 10/100 Mbps. They are IEEE 802.3u-compliant and use Auto-Negotiation to set the duplex mode setting for you automatically.

Note

In order for a switch port to successfully Auto-Negotiate its duplex mode with a 10 or 100 Mbps end-node, the end-node should also be configured for Auto-Negotiation. Otherwise, a duplex mode mismatch can occur. A switch port using Auto-Negotiation defaults to half-duplex if it detects that the end-node is not using Auto-Negotiation. This results in a mismatch if the end-node is operating at a fixed duplex mode of full-duplex.

Store-and-Forward

The GS910 series switch uses store-and-forward as the method for receiving and transmitting frames. When an Ethernet frame is received on a switch port, the switch does not retransmit the frame out the destination port until it has received the entire frame and stored the frame in a port buffer. It then examines the frame to determine if it is a valid frame. Invalid frames, such as fragments or runts, are discarded by the switch. This insures that only valid frames are transmitted out the switch ports and that damaged frames are not propagated on your network.

Backpressure and Flow Control

To maintain the orderly movement of data between the end-nodes, an Ethernet switch may periodically need to signal an end-node to stop sending data. This can occur under several circumstances. For example, if two end-nodes are operating at different speeds, the switch, while transferring data between the end-nodes, might need to instruct the faster end-node to stop transmitting data to allow the slower end-node to catch up. An example of this would be when a server operating at 100 Mbps is sending data to a workstation operating at only 10 Mbps.

How a switch signals an end-node to stop transmitting data differs depending on the duplex mode of the end-node and switch port. A twisted pair port operating in half-duplex mode stops an end-node from transmitting data by forcing a collision. A collision on an Ethernet network occurs when two end-nodes attempt to transmit data using the same data link at the same time. A collision causes an end-node to stop sending data, wait for a brief period of time, and then retransmit the same data. Once the switch is ready to receive data again, the switch stops forcing collisions. This is referred to as backpressure.

A port operating in full-duplex mode uses PAUSE frames, as specified in the IEEE 802.3x standard, to stop the transmission of data from an end-node. Whenever the switch wants an end-node to stop transmitting data, it issues this frame. The frame instructs the end-node to cease transmission for a period of time specified within the frame. The switch continues to issue PAUSE frames until it is ready again to receive data from the end-node. This is referred to as flow control.

Loop Prevention

The GS910 series switches are equipped with Loop Prevention, a feature that detects loops and blocks ports in order to reduce negative effects on the local network while keeping connectivity of devices. Loops in Ethernet networks can cause broadcast storms that consume network bandwidth and reduce network performance.

When Loop Prevention is enabled, the switch sends Loop Prevention frames periodically and detects a loop in the LAN when a port receives the Loop Prevention frame sent by the port itself. Then, the switch applies the loop prevention algorithm to block ports to relieve the loop.

When the switch detects a loop and blocks a port, the following actions are taken:

- ❑ The Loop LED starts blinking.
- ❑ The LED of the blocked port starts blinking.

In a topology with multiple GS910 series switches, these switches elect a root switch when Loop Prevention is enabled on all the switches. Initially, these switches are all root switches to send Loop Prevention frames, compare their MAC address, and elect a switch with the largest MAC address as a root switch. After a root switch is elected, the root switch sends Loop Prevention frames from its ports every two seconds. A non-root switch updates the Loop Prevention frames and forwards them. A non-root switch also maintains a timer for each port and sets a timer to 16 seconds. When receiving a Loop Prevention frame at a port, a non-root switch refreshes the timer of the port. When all timers of the non-root switch reach zero, the non-root switch changes itself to a root switch and sends Loop Prevention frames.

Examples with Multiple Loop Prevention Switches

In examples shown in Figure 13 on page 24, multiple GS910 series switches form links and all switches are Loop Prevention enabled. Switch C has a larger MAC address than Switch A and Switch B; Switch B has a larger MAC address than Switch A. First, these switches elect a root switch by comparing the MAC addresses. In cases 1 and 2, Switch B is elected as a root switch; in case 3, Switch C is elected as a root switch. Then the root switch initiates Loop Prevention frames and non-root switches update the frames and forward them. When detecting a loop, the root switch runs the Loop Prevention algorithm to decide which port to block, and blocks a port or ports to relieve the loop.

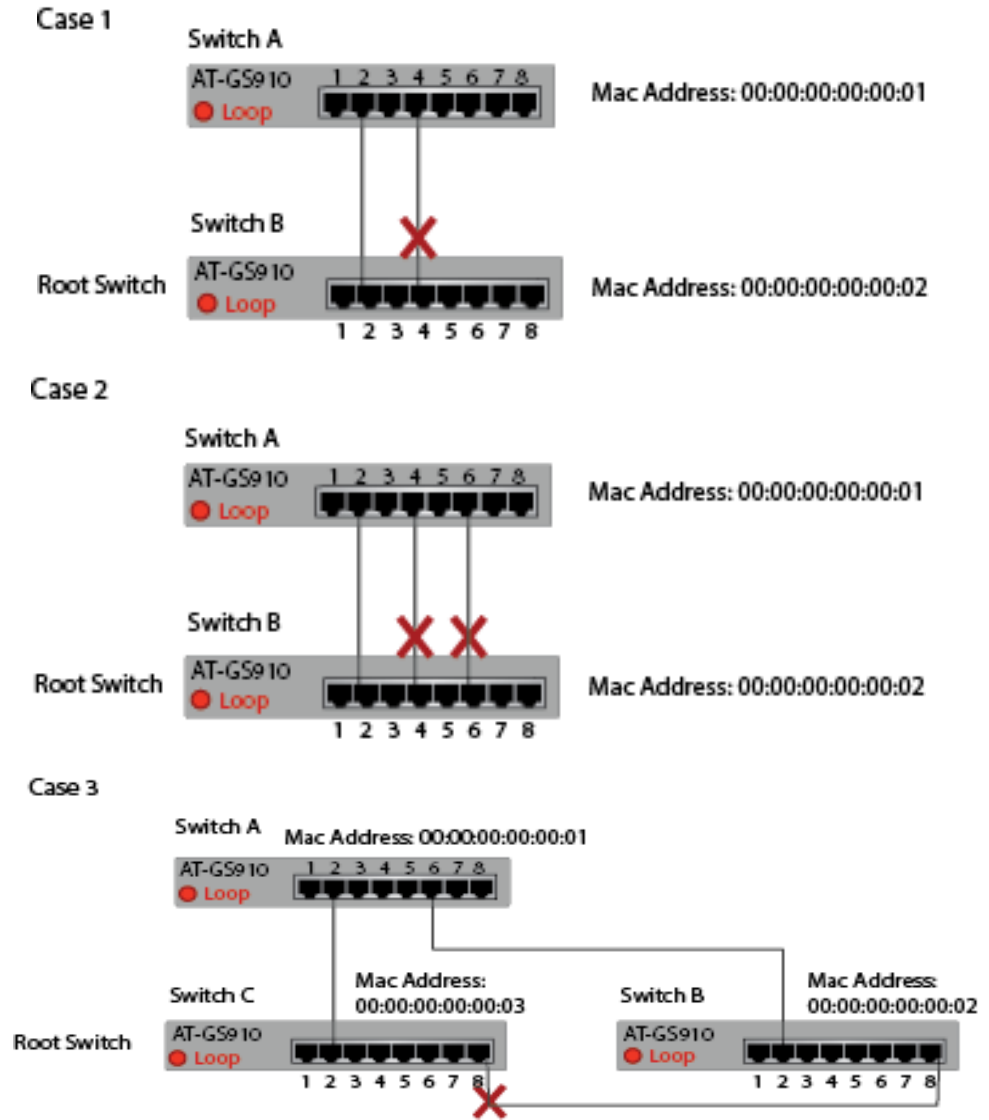

Figure 13. Multiple AT-GS910 Switches for Loop Prevention

Examples with Loop Prevention and Regular Switches

In examples shown in Figure 14 on page 25, the AT-GS910 switch and a regular switch form links. When Loop Prevention is enabled, the AT-GS910 switch sends Loop Prevention frames. When detecting a loop, the switch blocks a port or ports except the port with the smallest number.

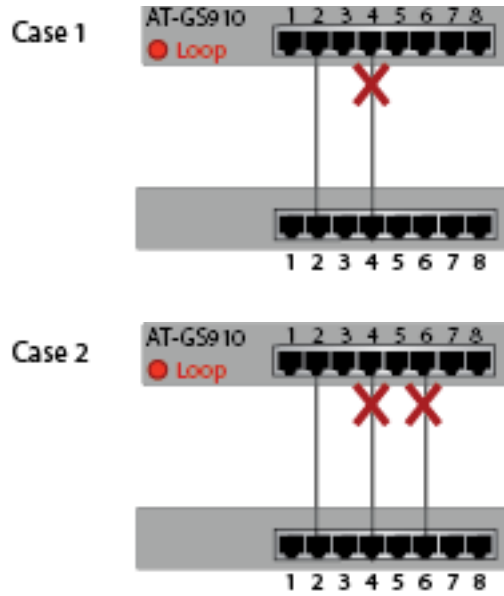

Figure 14. AT-GS910 and Regular Switches for Loop Prevention

In an example shown in Figure 15, the AT-GS910 switch and a regular switch form a link. The regular switch is causing a loop. When receiving a Loop Prevention frame, the AT-GS910 switch blocks its port.

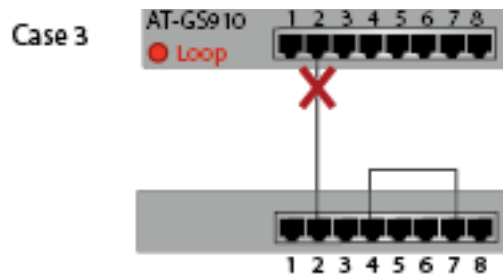

Figure 15. AT-GS910 and Regular Switches for Loop Prevention - Case 3

**Examples within
a Loop
Prevention
Switch**

In examples shown in Figure 16, the ports of the AT-GS910 switch connected. When Loop Prevention is enabled, the GS910 series switch blocks the port with the higher port number than the link partner port.

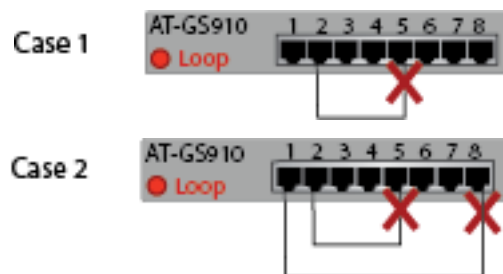

Figure 16. AT-GS910 Switch with Loop Prevention

Guidelines for Loop Prevention

Here are guidelines for using the Loop Prevention function:

- The switch must have a unique MAC address.
- In a topology with multiple switches with Loop Prevention enabled, these switches select a root switch.
- The switch with a larger MAC address is selected as a root switch.
- Only a root switch blocks its port(s) when a loop is detected.
- A port receives Loop Prevention frames even when the port is blocked.

Enabling Loop Protection

To enable Loop Prevention, set the Loop Prevention DIP switch on the front panel to "L/P ENABLE."

Disabling Loop Protection

To disable Loop Prevention, set the Loop Prevention DIP switch on the front panel to "L/P DISABLE."

Energy Efficiency Ethernet (EEE)

The GS910 Series switches support IEEE 802.3az Energy Efficiency Ethernet (EEE) when the twisted pair ports are operating at a speed of 100Mbps or 1000Mbps. When EEE is enabled on the switch, the power consumption to keep links at a these speeds is reduced during periods of low data activity.

To enable EEE, set the EEE DIP switch to “EEE ENABLE”; to disable EEE, set the EEE DIP switch to “EEE DISABLE.”

Chapter 2

Installation

This chapter contains the following sections:

- ❑ “Reviewing Safety Precautions” on page 30
- ❑ “Selecting a Site for the Switch” on page 32
- ❑ “Planning the Installation” on page 33
- ❑ “Unpacking the Switch” on page 34
- ❑ “Installing the Switch on a Table or Desktop” on page 36
- ❑ “Installing the Switch on a Wall” on page 37
- ❑ “Installing the Switch in an Equipment Rack” on page 44
- ❑ “Cabling the Switch” on page 48
- ❑ “Powering On the Switch” on page 49

Reviewing Safety Precautions

Review the following safety precautions before you begin to install the switch.

Note

Important: The  indicates that translations of the safety statement are available in the PDF document *Translated Safety Statements* posted on the Allied Telesis website at alliedtelesis.com/support.



Warning

To prevent electric shock, do not remove the cover. No user-serviceable parts inside. This unit contains hazardous voltages and should only be opened by a trained and qualified technician. To avoid the possibility of electric shock, disconnect electric power to the product before connecting or disconnecting the cables.  E1



Warning

Do not work on equipment or cables during periods of lightning activity.  E2



Warning

Power cord is used as a disconnection device. To de-energize equipment, disconnect the power cord.  E3



Warning

Class I Equipment. This equipment must be earthed. The power plug must be connected to a properly wired earth ground socket outlet. An improperly wired socket outlet could place hazardous voltages on accessible metal parts.  E4



Caution

Air vents must not be blocked and must have free access to the room ambient air for cooling.  E6



Warning

Operating Temperature. This product is designed for a maximum ambient temperature of 50 degrees C.  E57

Note

All Countries: Install product in accordance with local and National Electrical Codes. ⚡ E8

Note

The power input must be provided from SELV source only, per IEC 60950. Do not connect to a centralized DC battery bank. ⚡ E31

**Warning**

An insecurely attached device on a wall may fall and the falling device may lead to damaging itself or causing injuries. ⚡ E96

**Warning**

Do not install the device on an unstable wall or a wall affected by vibration or impact. The device may fall and falling device may lead to damaging itself or causing injuries. ⚡ E97

**Warning**

Do not install the device high on a wall. The device may fall and the falling device may lead to damaging itself or causing injuries. ⚡ E98

**Warning**

Disconnecting the Device: If the device becomes damaged or you encounter abnormality with the device, disconnect the power plug from the AC wall outlet immediately. ⚡ E100

**Warning**

Use appropriate screws to attach the device and brackets to a 19-inch rack. If a device is installed insecurely in a rack, it may fall, potentially causing injuries or damage to the device. ⚡ E104

Selecting a Site for the Switch

Observe the following requirements when choosing a site for the GS910 series switch:

- ❑ If you plan to install the switch on a table, make sure that the table is level and secured.
- ❑ If you plan to install the switch on a wall, make sure that the wall is straight and secured.
- ❑ If you plan to install the switch in an equipment rack, make sure that the rack is safely secured and it will not tip over. Devices in a rack should be installed starting at the bottom, with the heavier devices near the bottom of the rack.
- ❑ The power outlet for the switch should be located near the unit and should be easily accessible.
- ❑ The site should provide for easy access to the ports on the back of the switch and the LEDs on the front of the switch should be easily viewed.
- ❑ To allow proper cooling off the switch, air flow around the unit and through its vents on the side should not be restricted.
- ❑ Do not place objects on top of the switch.
- ❑ Do not expose the switch to moisture or water.
- ❑ Ensure that the site is a dust-free environment.
- ❑ Use dedicated power circuits or power conditioners to supply reliable electrical power to the network devices.

Planning the Installation

Table 5 contains the cabling specifications for the twisted pair ports.

Table 5. Twisted Pair Cabling and Distances

Speed	Type of Cable	Maximum Operating Distance
10 Mbps	Category 3 or better unshielded twisted pair cable	100 m (328 ft)
100 Mbps	Category 5 or unshielded twisted pair cable	100 m (328 ft)
1000 Mbps	Four-pair Category 5e unshielded twisted pair cable	100 m (328 ft)

Note

The twisted pair ports on the switch feature Auto-MDI when operating at either 10 or 100 Mbps. Each port is individually configured as MDI or MDI-X when connected to an end-node. Consequently, you can use a straight-through twisted pair cable when connecting any network device to a twisted pair port on the switch. A port operating at 10 or 100 Mbps uses four of the eight strands in twisted pair wiring.

Unpacking the Switch

To unpack the GS910 series switch, perform the following procedure:

1. Remove all components from the shipping package.

Note

Store the packaging material in a safe location. You must use the original shipping material if you need to return the unit to Allied Telesis.

2. Place the switch on a level, secure surface.
3. Verify that the hardware components are included in your switch package. Table 6 shows a list of the components.

Table 6. Contents in the Shipping Box





Model	AC Power Cord	AC Adapter	Brackets
AT-GS910/5	X		
AT-GS910/5E		X	
AT-GS910/8	X		
AT-GS910/8E		X	
AT-GS910/16	X		X
AT-GS910/24	X		X

4. Verify that all components for the bracket kit are included in your shipping box as listed in Table 7.

Note

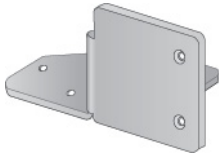
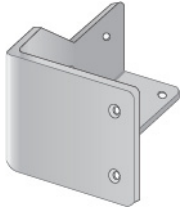
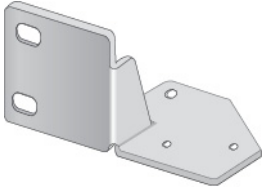
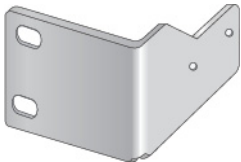
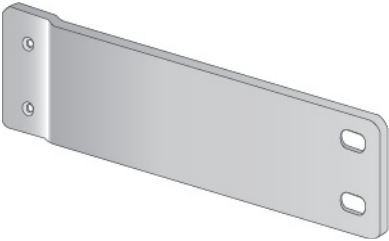
This step applies only for the AT-GS910/16 and AT-GS910/24 switches.

Table 7. Components in the Bracket Kit

	AT-GS910/16	AT-GS910/24
Bracket for the right side of the switch		
Bracket for the left side of the switch		
Extension		
Four M3x6mm screws for attaching the brackets to the switch		
Two M4x6mm screws for attaching the right side bracket and extension		

5. If any item is missing or damaged, contact your Allied Telesis sales representative for assistance.

Installing the Switch on a Table or Desktop

To install the switch on a table or desktop, perform the following procedure:

1. Remove all the items from the packaging.
2. Store the packaging material in a safe place.

In the event a problem occurs and you need to return the unit, use as much of the original shipping material as possible.

3. Place the switch on a flat and secure surface, leaving ample space around the switch for ventilation.
4. Proceed to "Cabling the Switch" on page 48 for the cable installation.

Installing the Switch on a Wall





The AT-GS910/5, AT-GS910/8, AT-GS910/8E, AT-GS910/16, and AT-GS910/24 switches can be mounted on a wall.

Guidelines for Installing the Switch on a Wall

Before planning to install the switch on a wall, review the following guidelines:

- ❑ To install the AT-GS910/16 or AT-GS910/24 switch, use the brackets included in the shipping box.
- ❑ To install the AT-GS910/5, AT-GS910/8, or AT-GS910/8E switch, you must purchase the AT-BRKT-J23 wall mount brackets separately.
- ❑ The AT-GS910/5, AT-GS910/8, AT-GS910/8E, and AT-GS910/16 switches can be mounted on the wall with the front panel facing left or right. The AT-GS910/24 switch must be mounted on the wall with the rear panel facing left. See Table 8.

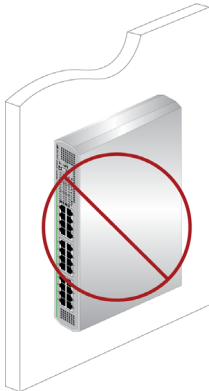
Table 8. Correct and Incorrect Orientations

	Front Panel Facing-Left	Rear Panel Facing-Left
AT-GS910/5 AT-GS910/8 AT-GS910/8E AT-GS910/16		
AT-GS910/24		

Note

To install the AT-GS910/24 switch on the wall, you must install the switch with the rear panel facing to the left in order for the switch to have proper air flow.

- ❑ Mounting the front panel facing up or down on the wall is incorrect for the AT-GS910/5, AT-GS910/8, AT-GS910/8E, AT-GS910/16, and AT-GS910/24 switches. See Figure 17 as examples.

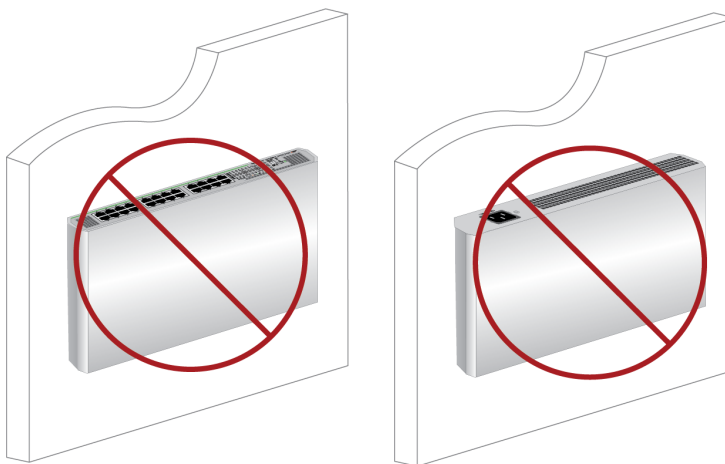

Figure 17. Incorrect Wall Installation



Warning

An insecurely attached device on a wall may fall and the falling device may lead to damaging itself or causing injuries. ⚡ E96



Warning

Do not install the device on an unstable wall or a wall affected by vibration or impact. The device may fall and falling device may lead to damaging itself or causing injuries. ⚡ E97



Warning

Do not install the device high on a wall. The device may fall and the falling device may lead to damaging itself or causing injuries. ⚡ E98

Note

Installing the device on a wall may damage the wall paint.

What to Prepare for Installation with Brackets

You need the following items to install the switch on a wall:

- A switch
- One pair of brackets (For more information, see “Wall and Rack Mount Brackets” on page 16.)
- Four screws to attach the brackets to a wall
- Four plastic anchors for the screws
- Phillips-head screwdriver
- Pencil

Note

Screws and plastic anchors are not included in the shipping box. You must provide screws that hold the switch securely to the wall.

Installing the AT-GS910/5, AT-GS910/8, or AT-GS910/8E Switch on a Wall

To install the AT-GS910/5, AT-GS910/8, or AT-GS910/8E switch on a wall, see “Installation Using the AT-BRKT-J23 Wall Mount Kit” on page 51.

Installing the AT-GS910/16 Switch on a Wall

To install the AT-GS910/16 switch on a wall, perform the following procedure:

1. Place all the items from the packaging on a work table.
2. Turn the switch over and remove the rubber feet on the bottom of the switch using a Phillips-head screwdriver.
3. Orient the brackets against the sides of the switch and secure them to the switch with the four screws as shown in Figure 18 on page 39.

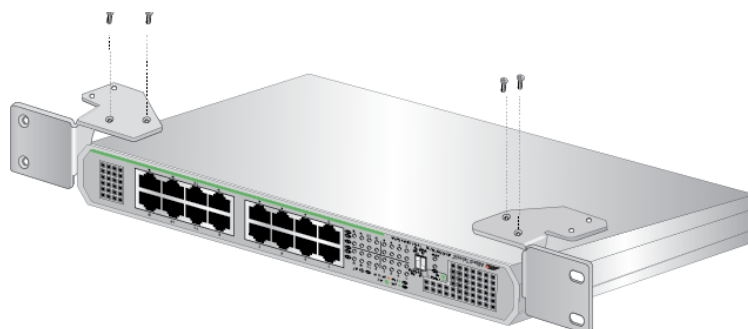

Figure 18. Attaching the Brackets to the AT-GS910/16 Switch

4. Have another person hold the switch with the brackets at the wall location where the switch is to be installed, while you use a pencil to mark the wall with the locations of the four holes in the brackets. See Figure 19 as an example.

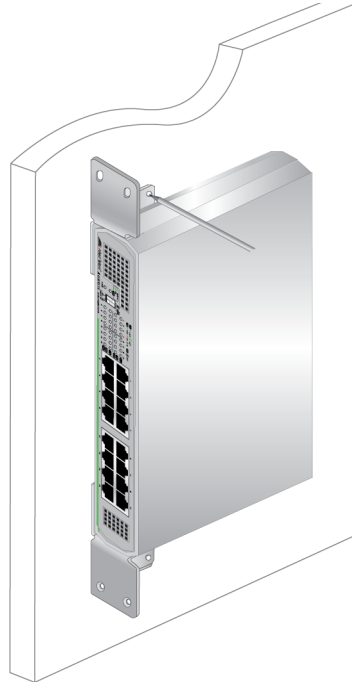

Figure 19. Marking the Screw Hole Locations

5. Pre-drill the marked locations on the wall.
6. Install the four plastic anchors into the wall in the holes drilled in Step 5.

7. Position the switch on the wall and drive screws through the holes to attach the brackets on the wall. See Figure 20.

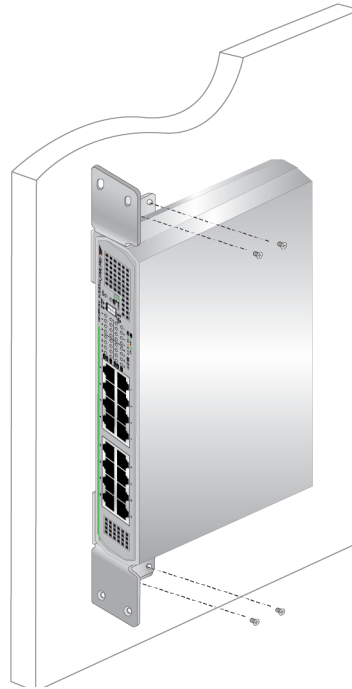

Figure 20. Driving the Screws through the Holes

8. Make sure that the two brackets are installed securely.
9. Proceed to “Cabling the Switch” on page 48.

Installing the AT-GS910/24 Switch on a Wall

To install the AT-GS910/24 switch on a wall, perform the following procedure:

Note

To install the AT-GS910/24 switch on the wall, you must install the switch with the rear panel facing to the left in order for the switch to have proper air flow.

1. Place all the items from the packaging on a work table.
2. Turn the switch over and remove the rubber feet on the bottom of the switch using a Phillips-head screwdriver.
3. Turn the switch over.

4. Orient the brackets against the sides of the switch and secure them to the switch with the four screws as shown in Figure 21.

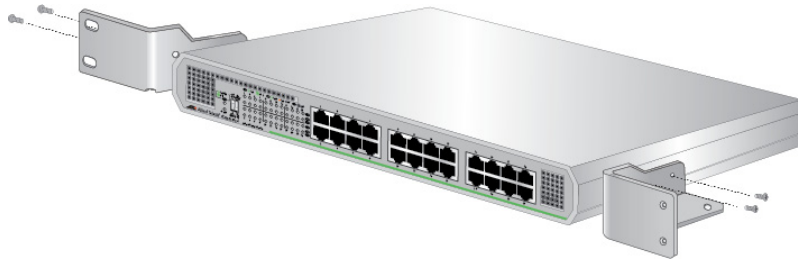

Figure 21. Attaching the Brackets to the AT-GS910/24 Switch

5. Have another person hold the switch with the brackets at the wall location where the switch is to be installed, while you use a pencil to mark the wall with the locations of the four holes in the brackets. See Figure 22 as an example.

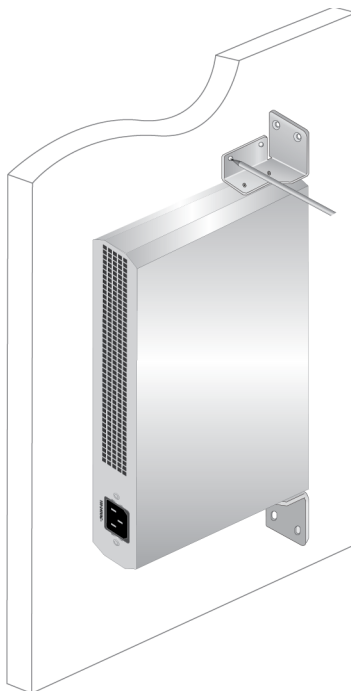

Figure 22. Marking the Screw Hole Locations

6. Pre-drill the marked locations on the wall.
7. Install the four plastic anchors into the wall in the holes drilled in Step 6.

8. Position the switch on the wall and drive screws through the holes to attach the brackets on the wall. See Figure 23.

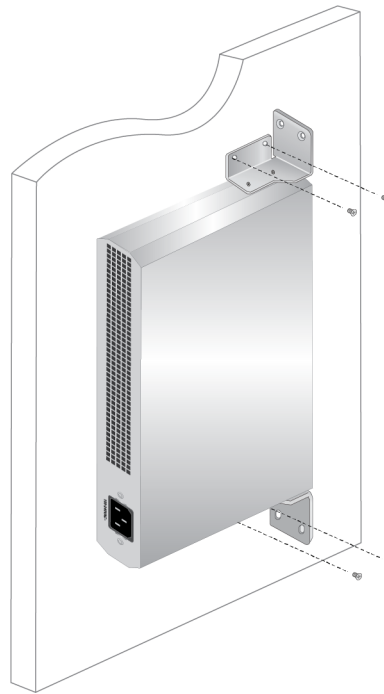

Figure 23. Driving the Screws through the Holes

9. Make sure that the two brackets are installed securely.
10. Proceed to “Cabling the Switch” on page 48.

Installing the Switch in an Equipment Rack

The AT-GS910/8, AT-GS910/8E, AT-GS910/16 and AT-GS910/24 switches can be mounted on a 19-inch equipment rack.

Guidelines for Installing the Switch in a Rack

Before planning to install the switch on an equipment rack, review the following guidelines:

- To install the AT-GS910/16 or AT-GS910/24 switch, use the brackets included in the shipping box.
- To install the AT-GS910/8 or AT-GS910/8E switch, you must purchase the AT-RKMT-J08 rack mount brackets separately.

What to Prepare for Installation in a Rack

You need the following items to install the switch in an equipment rack:

- A switch
- One pair of brackets (For more information, see “Wall and Rack Mount Brackets” on page 16.)
- 19-inch equipment rack
- Four screws for the equipment rack
- Phillips-head screwdriver

Note

Screws for a 19-inch equipment rack are not included in the shipping box.

Installing the AT-GS910/8 or AT-GS910/8E Switch in a Rack

To install the AT-GS910/8 or AT-GS910/8E switch in an equipment rack, see “Installation Using the AT-RKMT-J08 Rack Mount Kit” on page 57.

Installing the AT-GS910/16 Switch in a Rack

To install the AT-GS910/16 switch in an equipment rack, perform the following procedure:

1. Place all the items from the packaging on a work table.

2. Attach the extension to the bracket with the M4x6mm screws using a Phillips-head screw driver as shown in See Figure 24.

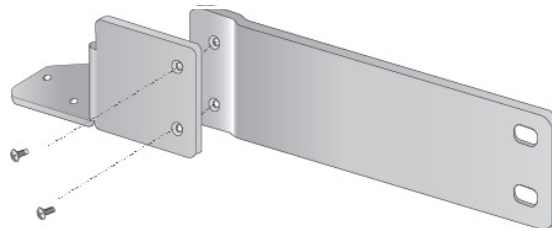

Figure 24. Attaching the Extension to the Bracket

3. Turn the switch upside down and place it on a table.
4. Remove the rubber feet from the bottom of the switch using a Phillips-head screwdriver.
5. Attached the brackets to the switch with the M3x6mm screws using a Phillips-head screwdriver. See Figure 25.

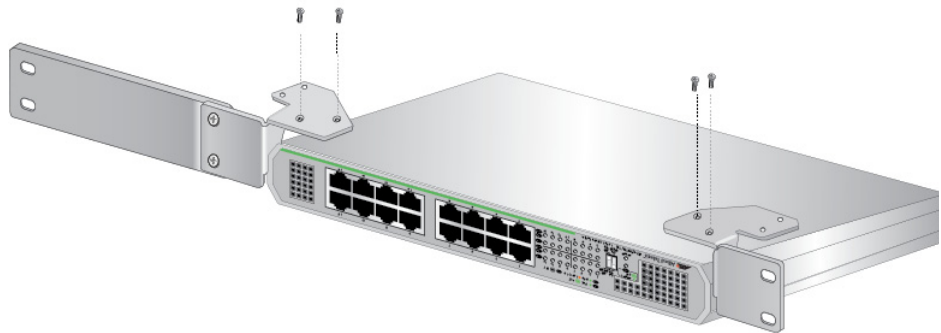

Figure 25. Attaching the Brackets to the Switch

6. Turn the switch over.
7. Mount the switch in a standard 19-inch equipment rack with four equipment rack screws as shown in Figure 26 on page 46.

Note

The screws for an equipment rack are not included in the shipping box.

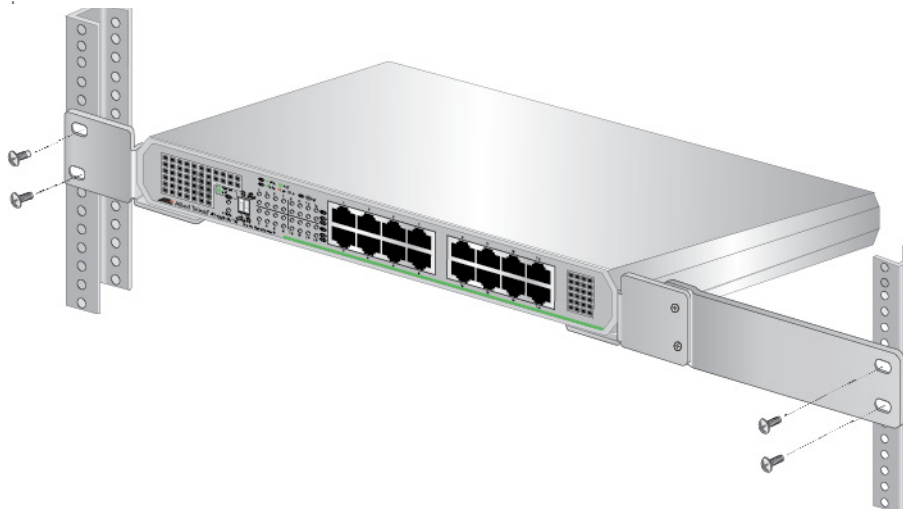

Figure 26. Attaching the Switch to an Equipment Rack

8. Proceed to “Cabling the Switch” on page 48.

Installing the AT-GS910/24 Switch in a Rack

To install the AT-GS910/24 switch in an equipment rack with the brackets that come with the switch, perform the following procedure:

1. Place all the items from the packaging on a work table.
2. Attach the extension to the bracket with the M4x6mm screws using a Phillips-head screw driver as shown in Figure 27.

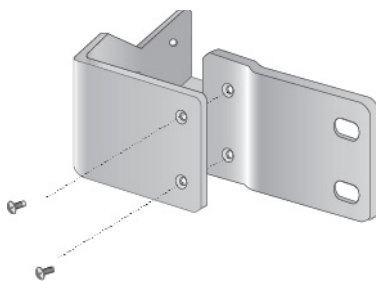

Figure 27. Attaching the Extension to the Bracket

3. Attach the brackets to the switch with the M3x6mm screws using a Phillips-head screwdriver. See Figure 28.

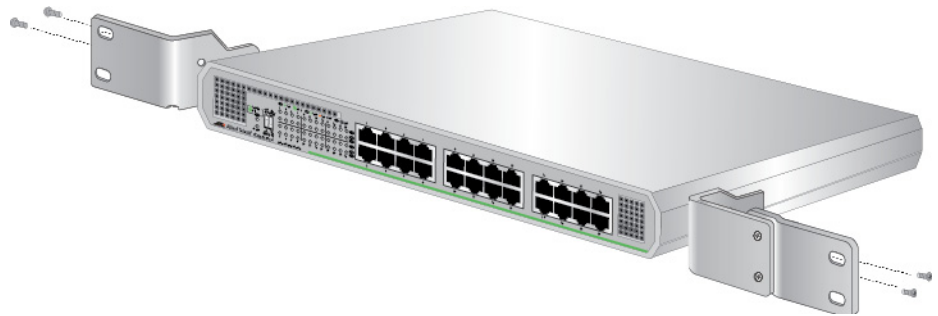

Figure 28. Attaching the Brackets to the Switch

4. Mount the switch in a standard 19-inch equipment rack with four equipment rack screws as shown in Figure 29.

Note

The screws for an equipment rack are not included in the shipping box.

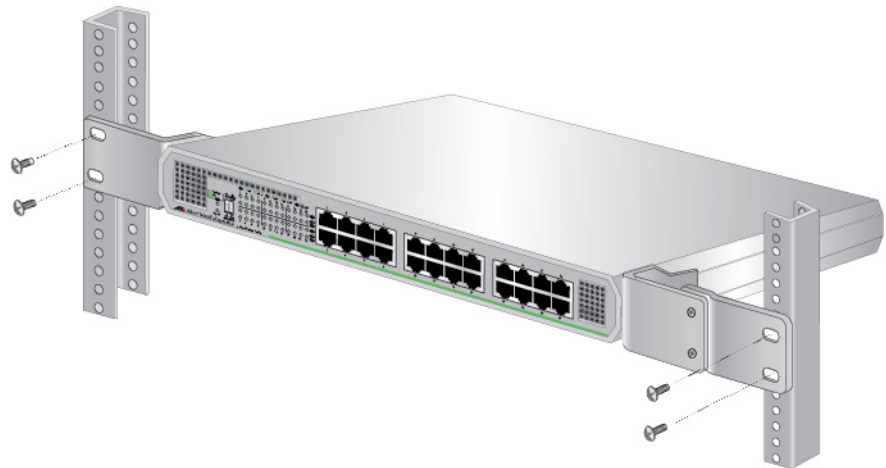

Figure 29. Attaching the Switch to an Equipment Rack

5. Proceed to “Cabling the Switch” on page 48.

Cabling the Switch

After installing the switch on the desktop, connect twisted pair cables to the ports on the GS910 series switch.

When connecting a twisted pair cable to a port, observe the following guidelines:

- ❑ An RJ-45 connector should fit snugly into the port on the switch. The tab on the connector should lock the connector into place.
- ❑ The ports on the switch are auto-MDI/MDI-X. You can use a straight-through twisted pair cable to connect any type of network device to a port on the switch.
- ❑ The network should not contain data loops, which can adversely affect network performance. A data loop exists when two or more network devices can communicate with each other over more than one data path.

Powering On the Switch

To power on the switch, perform the following procedure:

1. Plug the power cord into the power connector on the back of the switch.
2. If your switch is the AT-GS910/5E or AT-GS910/8E switch with a DC power supply socket, turn the power cord clockwise one-quarter to lock, as shown in Figure 30.



Figure 30. Locking the Power Cord for the DC Power Supply Socket

3. Plug the other end of the power cord into a wall outlet.



Warning

Power cord is used as a disconnection device. To de-energize equipment, disconnect the power cord. ⚡ E3

Note

Pluggable Equipment. The socket outlet shall be installed near the equipment and shall be easily accessible. ⚡ E5

4. Verify that the POWER LED is green. If the LED is OFF, see Chapter 5, “Troubleshooting” on page 65.

The switch is now powered on and ready for network operations.



Warning

Disconnecting the Device: If the device becomes damaged or you encounter abnormality with the device, disconnect the power plug from the AC wall outlet immediately. ⚡ E100

Chapter 3

Installation Using the AT-BRKT-J23 Wall Mount Kit

This chapter explains the procedures how to install a switch on a wall using the AT-BRKT-J23 wall mount kit.

It contains the following sections:

- ❑ “Reviewing Safety Precautions” on page 52
- ❑ “Unpacking the AT-BRKT-J23 Wall Mount Kit” on page 53
- ❑ “Installing a Switch Using the AT-BRKT-J23 Wall Mount Kit” on page 54

Reviewing Safety Precautions

Before you begin to install the switch using the AT-BRKT-J23 wall mount kit, review "Reviewing Safety Precautions" on page 30.

Unpacking the AT-BRKT-J23 Wall Mount Kit

To unpack the AT-BRKT-J23 wall mount kit, perform the following procedure:

1. Remove all components from the shipping package.

Note

Store the packaging material in a safe location. You must use the original shipping material if you need to return the unit to Allied Telesis.

2. Verify that One pair of brackets is included in your wall mount package listed in Table 9.

Table 9. Components in the AT-BRKT-J23 Wall Mount Kit

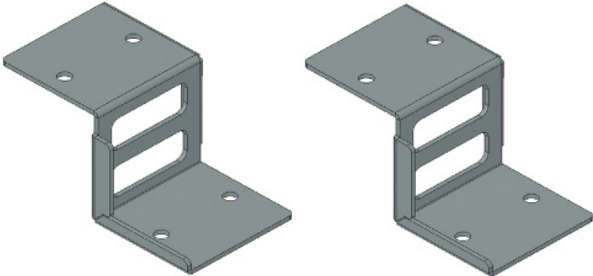
	Components
One pair of brackets	

3. If any item is missing or damaged, contact your Allied Telesis sales representative for assistance.

Installing a Switch Using the AT-BRKT-J23 Wall Mount Kit

This section shows you steps to install a switch on a wall using the AT-BRKT-J23 kit.

What to Prepare

Before installing a switch on a wall, make sure that the following items are ready.

- An AT-BRKT-J23 wall mount kit
- Four screws to attach the brackets to a wall
- Four plastic anchors for the screws
- Phillips-head screwdriver
- Pencil

Note

Screws and plastic anchors are not included in the shipping box. You must provide screws that hold the switch securely to the wall.

Installing a Switch Using the Wall Mount Kit

To install the switch on a wall, perform the following procedure:

1. Orient the brackets against the sides of the switch.
2. Have another person hold the switch with the brackets at the wall location where the switch is to be installed, while you use a pencil to mark the wall with the locations of the four holes in the brackets. See Figure 31 as an example.

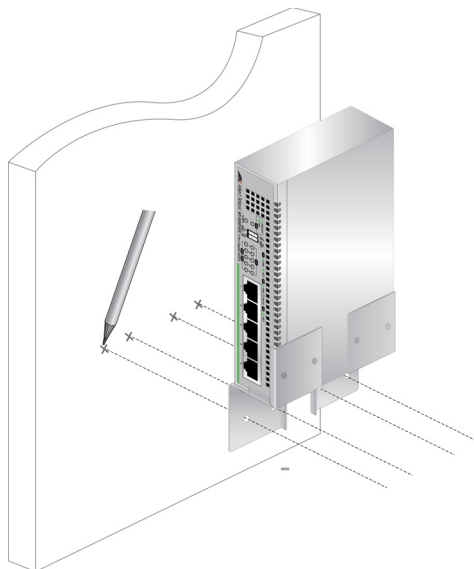

Figure 31. Marking the Screw Hole Locations

3. Pre-drill the marked locations on the wall at the locations marked in Step 2.
4. Install the four plastic anchors into the wall in the holes drilled in Step 3.
5. Position brackets on the wall and drive screws through the holes to attach the brackets on the wall. See Figure 32.

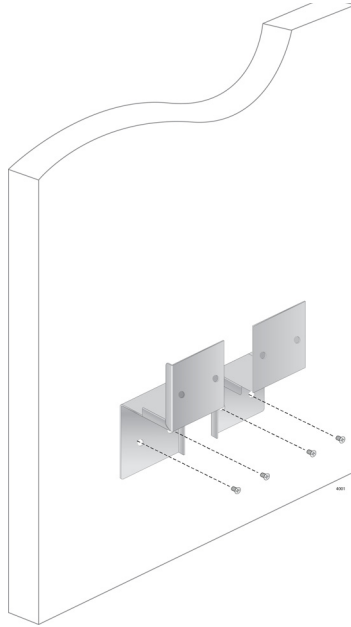

Figure 32. Driving the Screws through the Holes

6. Make sure that the two brackets are installed securely.

7. Slide the switch into the brackets on the wall as shown in Figure 33.

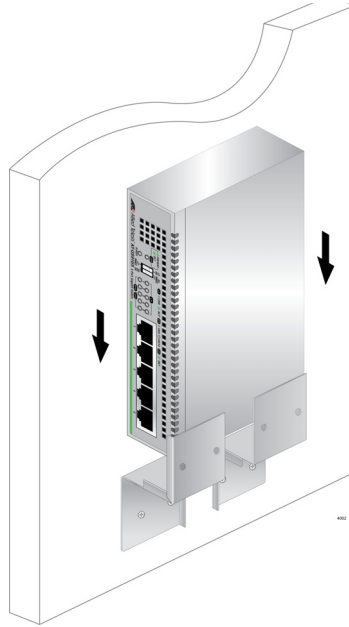

Figure 33. Placing the Switch into the Brackets

8. Proceed to “Cabling the Switch” on page 48.

Chapter 4

Installation Using the AT-RKMT-J08 Rack Mount Kit

This chapter explains the procedures how to install a switch in a 19-inch equipment rack using the AT-RKMT-J08 rack mount kit.

It contains the following sections:

- “Reviewing Safety Precautions” on page 58
- “Unpacking the AT-RKMT-J08 Rack Mount Kit” on page 59
- “Installing a Switch Using the AT-RKMT-J08 Rack Mount Kit” on page 61

Reviewing Safety Precautions

Before you begin to install the switch using the AT-RKMT-J08 rack mount kit, review "Reviewing Safety Precautions" on page 30.

Unpacking the AT-RKMT-J08 Rack Mount Kit

To unpack the AT-RKMT-J08 rack mount kit, perform the following procedure:

1. Remove all components from the shipping package.

Note

Store the packaging material in a safe location. You must use the original shipping material if you need to return the unit to Allied Telesis.

2. Verify that all hardware components are included in your rack mount package listed in Table 10.

Table 10. Components in the AT-RKMT-J08 Rack Mount Kit





	Components
Two Short Brackets	
Two Handles	
Two Cable Brackets	
Two Long Brackets	
Eight M3x6mm screws	

Table 10. Components in the AT-RKMT-J08 Rack Mount Kit (Continued)

	Components
Eight M4x6mm screws	 4004
Ten Tie-wrap	 4028

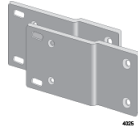
3. If any item is missing or damaged, contact your Allied Telesis sales representative for assistance.

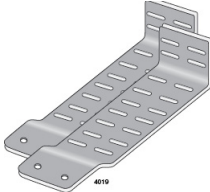
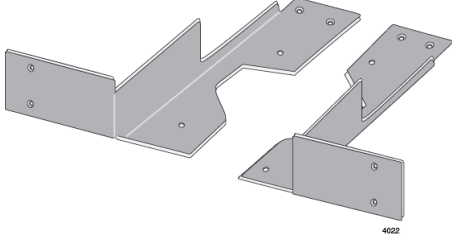
Installing a Switch Using the AT-RKMT-J08 Rack Mount Kit

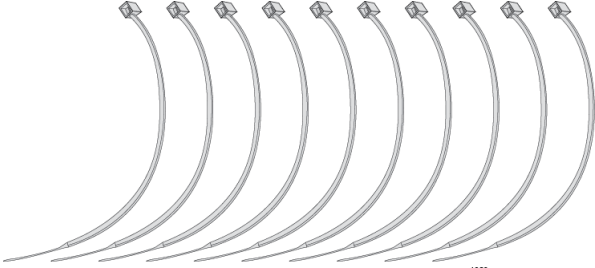
This section shows you steps to install a switch in an equipment rack using the AT-RKMT-J08 kit.

What to Prepare

Before installing a switch to an equipment rack, make sure that the following items are ready.

- An AT-RKMT-J08 rack mount kit
- The switch's power cord
- 19-inch equipment rack
- Four screws for the equipment rack
- Phillips-head screw driver

Installing a Switch Using the Rack Mount Kit

To install a switch in a rack using the AT-RKMT-J08 rack mount kit, perform the following procedure:

1. Place all the items from the packaging on a work table.
2. Attach the handle to the short bracket with M3x6mm screws using a Phillip-head screw driver as shown in Figure 34.

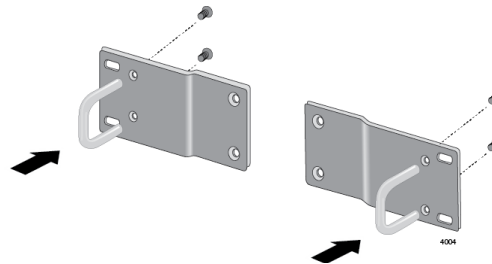

Figure 34. Attaching Handles to Brackets

3. Attach the short bracket and handle to the long bracket with M4x6mm screws using a Phillip-head screw driver as shown in Figure 35.

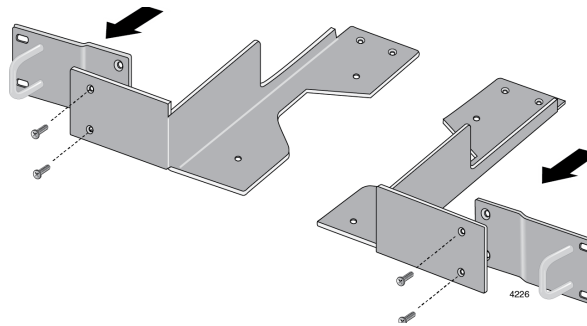

Figure 35. Attaching Brackets to Plates

4. Attach the cable bracket to the unit that you assembled in Step 3 with M4x6mm screws using a Phillip-head screw driver as shown in Figure 36.

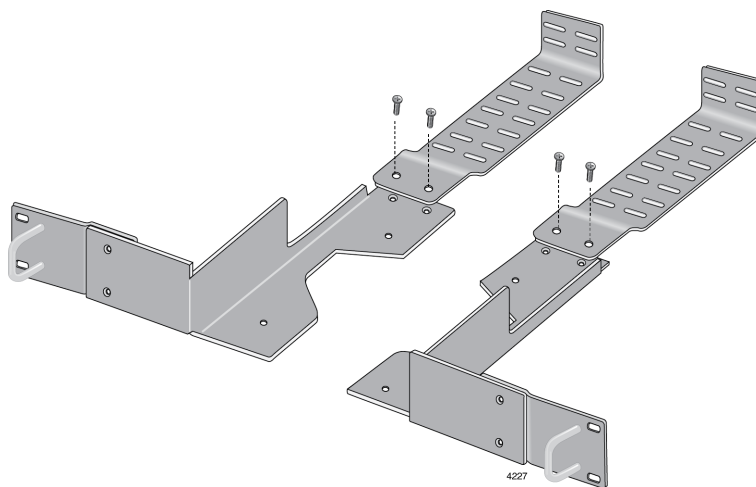

Figure 36. Attaching Cable Tray to Plates

5. Turn the switch over and place it on the work table.
6. Attach the units in Step 4 to the switch with M3x6mm screws using a Phillip-head screw driver as shown in Figure 37.

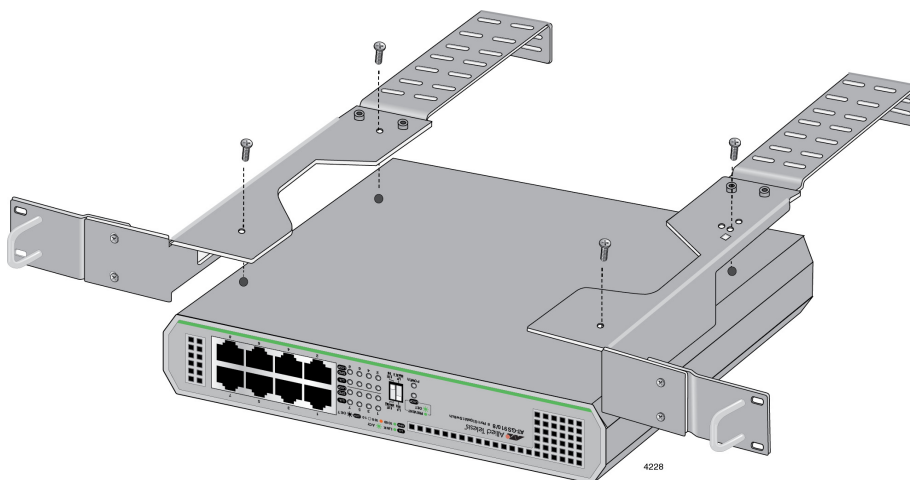

Figure 37. Attaching the Plates to the Switch

7. Mount the switch in a standard 19-inch equipment rack with four equipment rack screws as shown in Figure 38 on page 63.

Note

The screws are not included in the AT-RKMT-J08 rack mount kit.

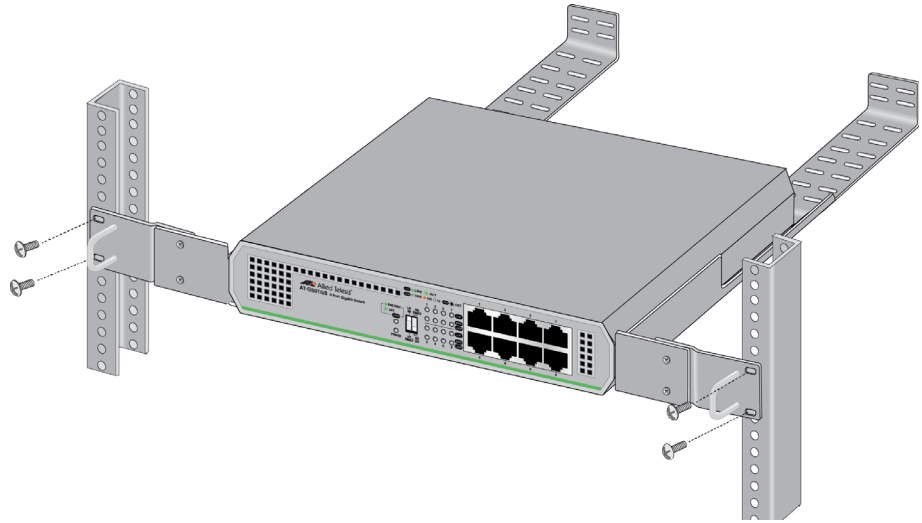

Figure 38. Attaching the Switch to Equipment Rack

8. Attach the power cord to the back panel of the switch.
9. Use a tie-warp to secure the power cord, as shown in Figure 39.

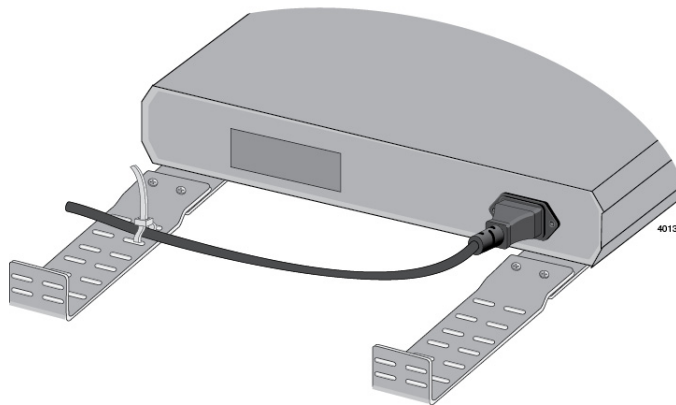

Figure 39. Securing the Power Cord Using a Tie-wrap

Chapter 5

Troubleshooting

This chapter contains information on how to troubleshoot the switch in the event a problem occurs.

Note

If you are still unable to resolve the problem after following the instructions in this chapter, contact Allied Telesis Technical Support for assistance. Refer to “Contacting Allied Telesis” on page 9.

Check the POWER LED on the front of the switch. If the LED is OFF, indicating that the unit is not receiving power, do the following:

- Verify that the power cord is securely connected to the power source and to the connector on the back panel of the switch.
- Verify that the power outlet or power supply has power by connecting another device to it.
- Try connecting the unit to another power source.
- Try using a different power cord.
- Verify that the voltage from the power source is within the required levels for your region.

Verify that the L/A LED for each port is green. If an L/A LED is OFF, do the following:

- Verify that the end-node connected to the port is powered ON and is operating properly.
- Verify that the twisted pair cable is securely connected to the port on the switch and to the port on the end-node.
- Ensure that the twisted pair cable does not exceed 100 meters (328 feet).
- Verify that you are using the appropriate category of twisted pair cable: Category 3 or better for 10 Mbps operation, Category 5 for 100 Mbps operation, and four-pair Category 5e for 1000 Mbps.

Appendix A

Technical Specifications

This appendix contains the following sections:

- “Physical Specifications”
- “Environmental Specifications”
- “Safety and Electromagnetic Emissions Certifications” on page 68
- “Power Specifications” on page 68
- “RJ-45 Twisted Pair Port Connectors” on page 69

Physical Specifications

Weight:

AT-GS910/5	500g (1.1 lbs)
AT-GS910/5E	415g (0.9 lbs)
AT-GS910/8	780g (1.7 lbs)
AT-GS910/8E	720g (1.6 lbs)
AC adapter for AT-GS910/5E and AT-GS910/8E	110g (0.2 lbs)
AT-GS910/16	1425g (3.14 lbs)
AT-GS910/24	2040g (4.5 lbs)

Environmental Specifications

Operating Temperature: 0° C to 50° C (32° F to 122° F)

Storage Temperature: -25° C to 70° C (-13° F to 158° F)

Operating Humidity: 5% to 90% non-condensing

Storage Humidity: 5% to 95% non-condensing

Safety and Electromagnetic Emissions Certifications

EMI	FCC Class A, CISPR 22 Class A, CISPR 32 Class A, EN55022 Class A, EN55032 Class A, RCM, VCCI, ICES-003 Class A
Immunity	EN55024, EN61000-3-2, EN61000-3-3
Electrical Safety	UL 60950-1 (cULus), UL-CB, UL-EU

Power Specifications

Model	Power Ratings	Frequency
AT-GS910/5	100 - 240 VAC, 0.10A	50/60 Hz
AT-GS910/5E	12 VDC, 0.70A	N/A
AT-GS910/8	100 - 240 VAC, 0.20A	50/60 Hz
AT-GS910/8E	12 VDC, 0.70A	N/A
AT-GS910/16	100 - 240 VAC, 0.30A	50/60 Hz
AT-GS910/24	100 - 240 VAC, 0.40A	50/60 Hz

RJ-45 Twisted Pair Port Connectors

This section lists the connectors and connector pinouts for the AT-GS910 series switch and its components.

Figure 40 illustrates the pin layout to an RJ-45 connector and port.

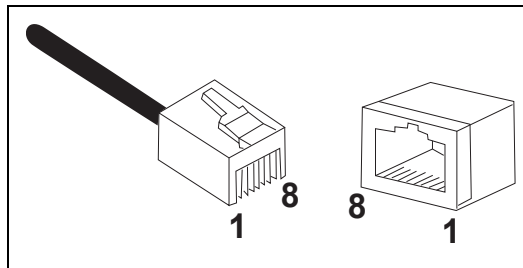

Figure 40. RJ-45 Connector and Port Pin Layout

Table 11 lists the RJ-45 pin signals when a twisted pair port is operating in the MDI configuration.

Table 11. MDI Pin Signals (10Base-T or 100Base-TX)

Pin	Signal
1	TX+
2	TX-
3	RX+
6	RX-

Table 12 lists the RJ-45 port pin signals when a twisted pair port is operating in the MDI-X configuration.

Table 12. MDI-X Pin Signals (10Base-T or 100Base-TX)

Pin	Signal
1	RX+
2	RX-
3	TX+
6	TX-

