

XS9 | 6MX Series

10 GIGABIT ETHERNET SWITCHES

- AT-XS916MXT
- AT-XS916MXS

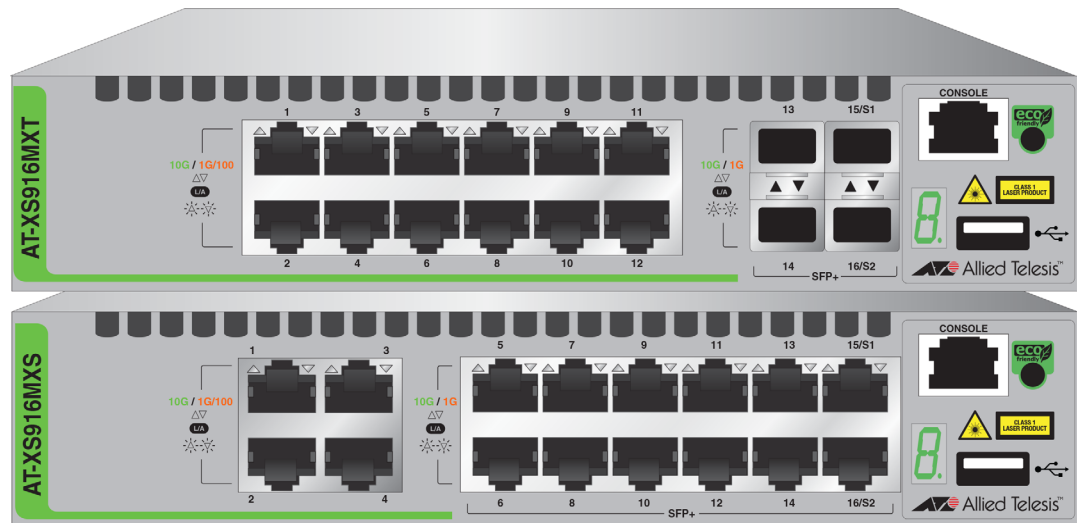

Installation Guide for Stand-alone Switches

Copyright © 2016 Allied Telesis, Inc.

All rights reserved. No part of this publication may be reproduced without prior written permission from Allied Telesis, Inc.

Allied Telesis and the Allied Telesis logo are trademarks of Allied Telesis, Incorporated. All other product names, company names, logos or other designations mentioned herein are trademarks or registered trademarks of their respective owners.

Allied Telesis, Inc. reserves the right to make changes in specifications and other information contained in this document without prior written notice. The information provided herein is subject to change without notice. In no event shall Allied Telesis, Inc. be liable for any incidental, special, indirect, or consequential damages whatsoever, including but not limited to lost profits, arising out of or related to this manual or the information contained herein, even if Allied Telesis, Inc. has been advised of, known, or should have known, the possibility of such damages.

Electrical Safety and Emissions Standards

This section contains the following:

- “US Federal Communications Commission”
- “Industry Canada”
- “Emissions, Immunity and Electrical Safety Standards” on page 4
- “Translated Safety Statements” on page 4

US Federal Communications Commission

Radiated Energy

Note

This equipment has been tested and found to comply with the limits for a Class A digital device pursuant to Part 15 of FCC Rules. These limits are designed to provide reasonable protection against harmful interference when the equipment is operated in a commercial environment. This equipment generates, uses, and can radiate radio frequency energy and, if not installed and used in accordance with this instruction manual, may cause harmful interference to radio communications. Operation of this equipment in a residential area is likely to cause harmful interference in which case the user will be required to correct the interference at his own expense.

Note

Modifications or changes not expressly approved of by the manufacturer or the FCC, can void your right to operate this equipment.

Industry Canada

Radiated Energy

This Class A digital apparatus complies with Canadian ICES-003.

Cet appareil numérique de la classe A est conforme à la norme NMB-003 du Canada.

Emissions, Immunity and Electrical Safety Standards

RFI Emissions FCC Class A, EN55022 Class A, EN61000-3-2, EN61000-3-3, VCCI Class A, RCM



Warning

In a domestic environment this product may cause radio interference in which case the user may be required to take adequate measures. ⚡ E70

EMC (Immunity) EN55024

Electrical Safety UL 60950-1 (CUL_{US}), CSA-C22 No. 60950-1 (CUL_{US}), EN60950-1 (TUV), EN60825-1 (TUV)



Warning

Laser Safety: EN60825 ⚡ L7

Translated Safety Statements

Important: The ⚡ indicates that translations of the safety statement are available in the PDF document “**Translated Safety Statements**” posted on the Allied Telesis website at alliedtelesis.com/support.

Contents

Preface	11
Document Conventions	12
Contacting Allied Telesis	13
Chapter 1: Overview	15
Features	16
XS916MX Models	16
100/1000/10000 Mbps Twisted Pair Ports	16
SFP/SFP+ Slots	16
S1 and S2 Stacking Ports	16
LEDs	16
Installation Options	16
MAC Address Table	17
Management Software and Interfaces	17
Management Methods	17
Front Panels	18
Management Panel	19
100/1000/10000Base-T and Twisted Pair Ports	20
Speed	20
Duplex Mode	20
Wiring Configuration	20
Maximum Distance	20
Port Pinouts	20
Cable Requirements	21
SFP/SFP+ Slots	22
Stacking Slots	23
eco-friendly Button	24
LEDs	25
LEDs for the Twisted Pair Ports	25
LEDs for the SFP Slots	25
LEDs for the Stacking Slots	26
Switch ID LED	27
USB Port	29
Console Port	30
Power Supply	31
Chapter 2: Beginning the Installation	33
Reviewing Safety Precautions	34
Choosing a Site for the Switch	38
Unpacking the Switch	39
Chapter 3: Installing the Switch	41
Installing the Switch on a Table	42
Installing the Switch in an Equipment Rack	43
Installing Two Switches in One Row	43
Installing a Switch in One Row	43
Installing the Switch on a Wall	46
What to Prepare for Wall Installation	46
Installing the Switch on a Wall	47
Chapter 4: Cabling the Networking Ports	49

- Cabling the Twisted Pair Ports 50
- Installing SFP/SFP+ Transceivers 51
 - Guidelines for SFP/SFP+ Transceivers..... 51
 - Installing SFP/SFP+ Transceivers..... 52
- Chapter 5: Powering On the Switch** 55
 - Powering On the Switch 56
 - Monitoring the Initialization Processes 58
 - Configuring the Switch for Stand-alone Operations..... 61
 - Starting a Local Management Session..... 61
 - Disabling VCStack..... 63
 - Specifying Ports in the Command Line Interface for Stand-alone Switches..... 66
- Chapter 6: Troubleshooting** 67
- Appendix A: Technical Specifications** 71
 - Physical Specifications 71
 - Environmental Specifications..... 72
 - Power Specifications 72
 - Certifications 73
 - RJ-45 Twisted Pair Port Pinouts..... 74
 - RJ-45 Style Serial Console Port Pinouts 75

Figures

Figure 1: AT-XS916MXT Switch Front Panel	18
Figure 2: AT-XS916MXS Switch Front Panel	18
Figure 3: XS916MX Series Management Panel	19
Figure 4: Stacking Transceiver	23
Figure 5: LEDs for the Twisted Pair Ports on the XS916MX Series Switch	25
Figure 6: SFP Slot LEDs	26
Figure 7: Switch ID LED	27
Figure 8: Switch ID LED Not in Low Power Mode	28
Figure 9: Switch ID LEDs in Low Power Mode	28
Figure 10: Rack Installation Options for the XS916MXSeries Switch	43
Figure 11: Turning the Switch Upside Down	44
Figure 12: Removing the Rubber Feet	44
Figure 13: Attaching the Handles to the Brackets	44
Figure 14: Installing the Brackets on the Switch	45
Figure 15: Mounting the Switch in an Equipment Rack	45
Figure 16: Positions of the XS916MX Series Switch on a Wall	46
Figure 17: Turning the Switch Upside Down	47
Figure 18: Removing the Rubber Feet	47
Figure 19: Attaching the Wall Brackets	47
Figure 20: Installing the Switch on the Wall	48
Figure 21: Removing the Dust Plug from an SFP/SFP+ Slot	52
Figure 22: Installing an SFP/SFP+ Transceiver	52
Figure 23: Removing the Dust Cover from an SFP Transceiver	53
Figure 24: Positioning the SFP Handle in the Upright Position	53
Figure 25: Connecting a Fiber Optic Cable to an SFP Transceiver	54
Figure 26: Installing the Retaining Clip	56
Figure 27: Raising the Retaining Clip	56
Figure 28: Plugging in the AC Power Cord	57
Figure 29: Lowering the Retaining Clip	57
Figure 30: Switch Initialization Messages	58
Figure 31: Switch Initialization Messages (Continued)	59
Figure 32: Switch Initialization Messages (Continued)	60
Figure 33: Connecting the Management Cable to the Console Port	62
Figure 34: User Exec Mode Prompt	63
Figure 35: SHOW STACK Command	63
Figure 36: Moving to the Global Configuration Mode	64
Figure 37: Confirmation Prompt for the NO STACK ENABLE Command	64
Figure 38: Returning to the Privileged Exec Mode	65
Figure 39: Saving the Changes with the WRITE Command	65
Figure 40: PORT Parameter in the Command Line Interface	66
Figure 41: RJ-45 Socket Pin Layout (Front View)	74

Tables

Table 1: Twisted Pair Cable for the 100/1000/10000Base-T Ports	21
Table 2: LEDs on the Twisted Pair Ports on the XS916MX Series Switch	25
Table 3: SFP Slot LEDs on the XS916MX Series Switch	26
Table 4: S1 and S2 Slot LEDs	27
Table 5: Components in the Shipping Box	39
Table 6: Product Dimensions	71
Table 7: Product Weights	71
Table 8: Ventilation Requirements	71
Table 9: Environmental Specifications	72
Table 10: Input Voltages	72
Table 11: Maximum Power Consumption	72
Table 12: Heat Dissipation	72
Table 13: Product Certifications	73
Table 14: Pin Signals for 10 and 100 Mbps	74
Table 15: Pin Signals for 1000 Mbps	74
Table 16: RJ-45 Style Serial Console Port Pin Signals	75

Preface

This guide contains the installation instructions for the XS916MX Series of Layer 2+ 10 Gigabit Ethernet switches. This preface contains the following sections:

- “Document Conventions” on page 12
- “Contacting Allied Telesis” on page 13

Note

This guide explains how to install the switches as stand-alone units. For instructions on how to install them in a stack configuration with Virtual Chassis Stacking (VCStack™), see the *XS916MX Series Installation Guide for VCStack*.

Document Conventions

This document uses the following conventions:

Note

Notes provide additional information.



Caution

Cautions inform you that performing or omitting a specific action may result in equipment damage or loss of data.



Warning

Warnings inform you that performing or omitting a specific action may result in bodily injury.

Contacting Allied Telesis

If you need assistance with this product, you may contact Allied Telesis technical support by going to the Support & Services section of the Allied Telesis web site at **www.alliedtelesis.com/support**. You can find links for the following services on this page:

- ❑ 24/7 Online Support — Enter our interactive support center to search for answers to your product questions in our knowledge database, to check support tickets, to learn about RMAs, and to contact Allied Telesis technical experts.
- ❑ USA and EMEA phone support — Select the phone number that best fits your location and customer type.
- ❑ Hardware warranty information — Learn about Allied Telesis warranties and register your product online.
- ❑ Replacement Services — Submit a Return Merchandise Authorization (RMA) request via our interactive support center.
- ❑ Documentation — View the most recent installation and user guides, software release notes, white papers, and data sheets for your products.
- ❑ Software Downloads — Download the latest software releases for your managed products.

For sales or corporate information, go to **www.alliedtelesis.com/purchase** and select your region.

Chapter 1

Overview

This chapter contains the following sections:

- “Features” on page 16
- “Front Panels” on page 18
- “Management Panel” on page 19
- “100/1000/10000Base-T and Twisted Pair Ports” on page 20
- “SFP/SFP+ Slots” on page 22
- “Stacking Slots” on page 23
- “eco-friendly Button” on page 24
- “LEDs” on page 25
- “USB Port” on page 29
- “Console Port” on page 30
- “Power Supply” on page 31

Note

This guide explains how to install the switches as stand-alone units. For instructions on how to install them in a stack configuration with Virtual Chassis Stacking (VCStack™), see the *XS916MX Series Installation Guide for VCStack*.

Features

The XS916MX series switches and their features are listed in this section:

XS916MX Models

Here are model names of the XS916MX Series switches:

- AT-XS916MXT
- AT-XS916MXS

100/1000/10000 Mbps Twisted Pair Ports

Here are the basic features of the 100/1000/10000 Mbps twisted pair ports:

- 4 or 12 ports per switch
- 100Base-TX, 1000Base-T, 1000Base-SX, and 10GBASE-T compliant
- IEEE 802.3u Auto-Negotiation compliant
- Auto-MDI/MDIX
- 100 meters (328 feet) maximum operating distance
- IEEE 802.3x flow control in full-duplex mode
- IEEE 802.3ab 1000Base-T
- IEEE 802.3an 10GBase-T
- Jumbo frames up to 9KB
- RJ-45 connectors

SFP/SFP+ Slots

The XS916MX series switch has two SFP/SFP+ slots: S1 and S2 Stacking Slots. For more information, see “SFP/SFP+ Slots” on page 22.

S1 and S2 Stacking Ports

The S1 and S2 slots are stacking ports for the VCStack feature. You can use the slots to build a stack of two switches. For more information, see the “Stacking Slots” on page 23.

LEDs

Here are the port LEDs:

- Link/activity LEDs for the twisted pair ports
- Link/activity LEDs for SFP/SFP+ slots
- Switch ID number LED
- eco-friendly button turns off the LEDs to conserve electricity

Installation Options

Here are the installation options for the switches:

- Desk or tabletop
- 19-inch equipment rack

- Wall

MAC Address Table

Here are the basic features of the MAC address tables of the switches:

- Storage capacity of 16,000 dynamic MAC address entries
- Storage capacity of 256 static MAC address entries
- Automatic learning and aging

Management Software and Interfaces

Here are the management software and interfaces:

- AlliedWare Plus Management Software
- Command line interface

Management Methods

Here are the methods for managing the switches:

- Local management through the Console port
- Remote Telnet and Secure Shell management
- SNMPv1, v2c, and v3

Front Panels

The front panels of the XS916MX Series switches are shown in Figure 1 and Figure 2.

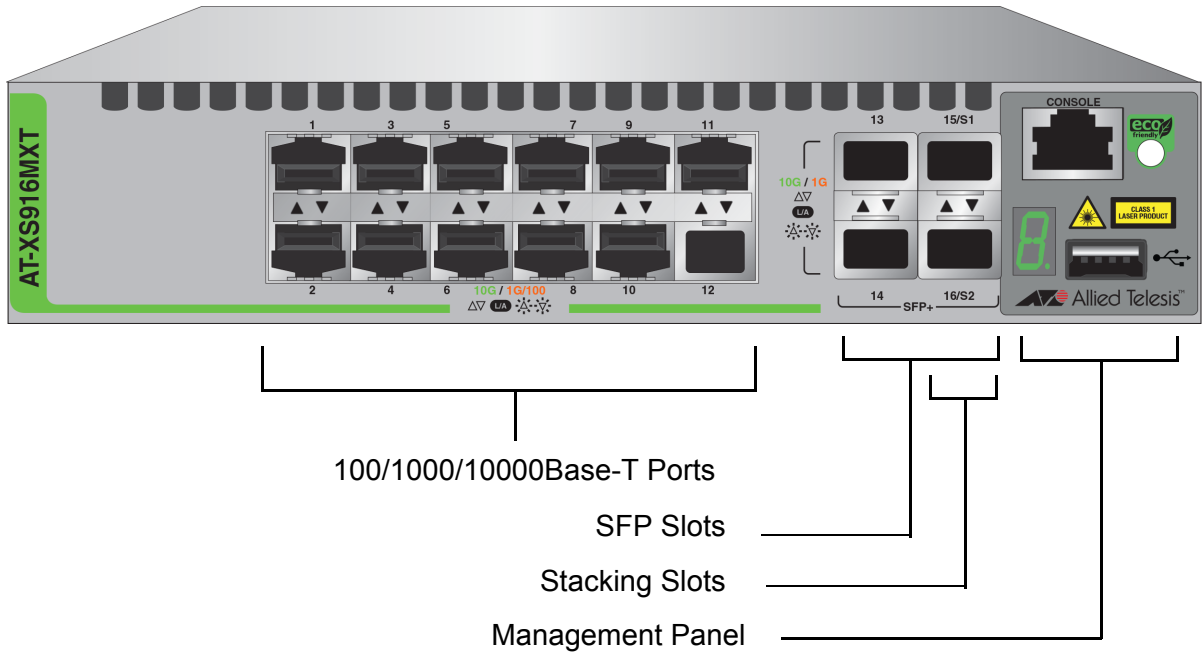

Figure 1. AT-XS916MXT Switch Front Panel

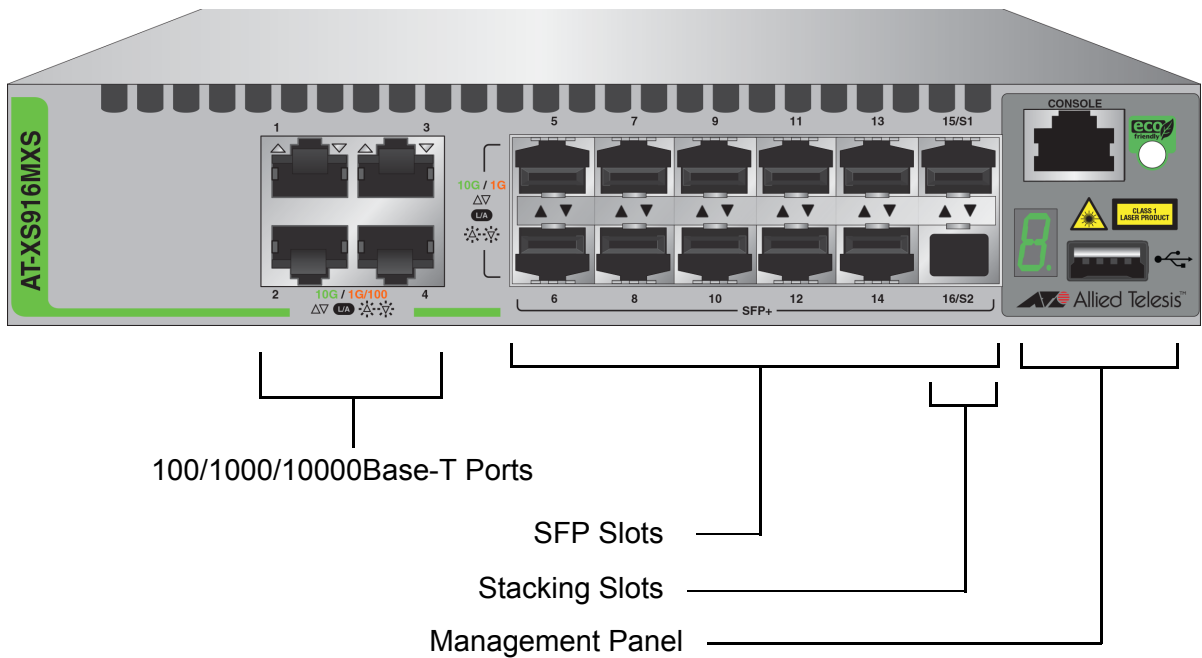

Figure 2. AT-XS916MXS Switch Front Panel

Management Panel

Figure 3 identifies the components in the management panels on the XS916MX Series switches.

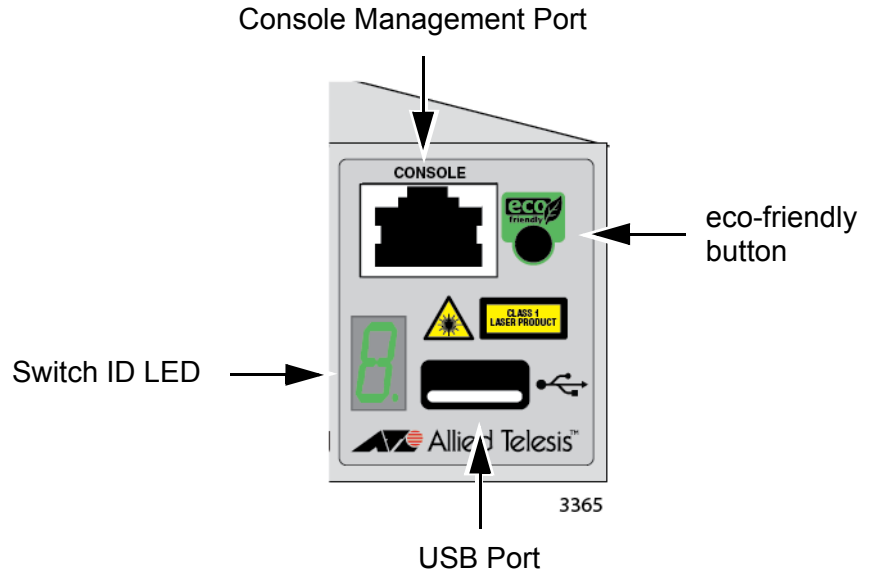

Figure 3. XS916MX Series Management Panel

100/1000/10000Base-T and Twisted Pair Ports

The XS916MXT series switches have 4 or 12 100/1000/10000Base-T ports.

Speed The ports can operate at 100 or 1000 Mbps, or 10 Gbps. The speeds may be set manually using the management software or automatically with Auto-Negotiation (IEEE 802.3u), the default setting.

Duplex Mode The twisted pair ports operate in full-duplex mode. You cannot change the duplex mode of a port manually.

Wiring Configuration The wiring configuration of a port operating at 100 Mbps can be MDI or MDI-X. The wiring configurations of a switch port and a network device connected with straight-through twisted pair cabling have to be opposite, such that one device is using MDI and the other MDI-X. For instance, a switch port has to be set to MDI-X if it is connected to a network device set to MDI.

The switch has the auto-MDI/MDI-X detection feature (IEEE 802.3ab-compliant) so that the switch automatically negotiates with network devices to establish their proper settings.

Maximum Distance The ports have a maximum operating distance of 100 meters (328 feet).

Port Pinouts See Table 14 on page 74 and Table 15 on page 74 for the port pinouts of the 100/1000/10000Base-T twisted pair ports.

Cable Requirements

The cable requirements of the ports are given in Table 1.

Table 1. Twisted Pair Cable for the 100/1000/10000Base-T Ports

Cable Type	100Mbps	1000Mbps	10Gbps
Standard TIA/EIA 568-B-compliant Category 3 shielded or unshielded cabling with 100 ohm impedance and a frequency of 16 MHz.	Yes	No	No
Standard TIA/EIA 568-A-compliant Category 5 or TIA/EIA 568-B-compliant Enhanced Category 5 (Cat 5e) shielded or unshielded cabling with 100 ohm impedance and a frequency of 100 MHz.	Yes	Yes	Yes
Standard TIA/EIA 568-B-compliant Category 6 or 6a shielded cabling.	Yes	Yes	Yes

SFP/SFP+ Slots

The XS916MX series switch has two SFP/SFP+ slots. You may use the transceivers to connect switches to other network devices over large distances, build high-speed backbone networks between network devices, or connect high-speed devices, such as servers, to your network.

Here is a list of supported pluggable transceivers:

- ❑ AT-SP10SR/I
- ❑ AT-SP10LR
- ❑ AT-SP10LR/I
- ❑ AT-SP10LRM
- ❑ AT-SP10LR20/I
- ❑ AT-SP10LR40/I
- ❑ AT-SP10ZR80/I
- ❑ AT-SP10ER40/I
- ❑ AT-SPTXa
- ❑ AT-SPSX
- ❑ AT-SPSX2
- ❑ AT-SPEX
- ❑ AT-SPLX10
- ❑ AT-SPLX40
- ❑ AT-SP10TW
- ❑ AT-StackXS/1.0

Note

SFP/SFP+ transceivers must be purchased separately.

Stacking Slots

The S1 and S2 slots on the front panel of the switch are used with special stacking transceivers to create a VCStack of two switches.

Here is a list of supported stacking transceivers:

- ❑ AT-SP10TW
- ❑ AT-StackXS/1.0

Note

Stacking cables must be purchased separately.

The stacking transceiver AT-SP10TW is shown in Figure 4 as an example. It has two SFP transceiver-style connectors and one meter of twinax cable.



Figure 4. Stacking Transceiver

The switches of a VCStack act as a single virtual unit. They synchronize their actions so that switching operations, like spanning tree protocols, virtual LANs, and static port trunks, span across all the units and ports. The two main advantages of stacks are:

- ❑ You can manage multiple units simultaneously, which can simplify network management.
- ❑ You have more flexibility with some of the features. For instance, a static port trunk on a stand-alone switch has to consist of ports from the same switch. In contrast, a static trunk on a stack may consist of ports from different switches in the same stack.

Note

This guide explains how to install the devices as stand-alone units. For instructions on how to install the switches in a stack with Virtual Chassis Stacking (VCStack), refer to the *XS916MX Series Installation Guide for VCStack*.

Note

The stacking slots may be used as regular networking ports.

eco-friendly Button

The eco-friendly button on the front panel of the switch is used to toggle the port LEDs on or off. You might turn off the LEDs to conserve electricity when you are not monitoring the device. You can also toggle the LEDs with the ECOFRIENDLY LED and NO ECOFRIENDLY LED commands in the Global Configuration mode of the command line interface. The switch is said to be operating in a low power mode when the LEDs are turned off.

Operating the switch in the low power mode with the LEDs turned off does not interfere with the network operations of the device.

The management software on the switch has a command that blinks the LEDs so that you can quickly and easily identify a specific unit among the devices in an equipment rack. It is the FINDME command. The command works on the switch even if you turned off the LEDs with the eco-friendly button or NO ECOFRIENDLY LED command.

The Switch ID LED is always on, but it displays different information depending on whether the LEDs are on or off. When the LEDs are on, the ID LED displays the ID number of the switch. When the switch is operating in the low power mode with the LEDs off, the ID LED indicates whether the switch is a stand-alone unit or the master or member switch of a VCStack, as detailed in Figure 9 on page 28.

Note

Before checking or troubleshooting the network connections to the ports on the switch, you should always check to be sure that the LEDs are on by either pressing the eco-friendly button or issuing the ECOFRIENDLY LED and NO ECOFRIENDLY LED commands in the Global Configuration mode of the command line interface.

LEDs

This section describes the functions of the LEDs.

LEDs for the Twisted Pair Ports

The twisted pair ports on the XS916MX series switch has one status LED that displays link and activity information. The LEDs are shown in Figure 5.

Status LED for the Top Port Status LED for the Bottom Port

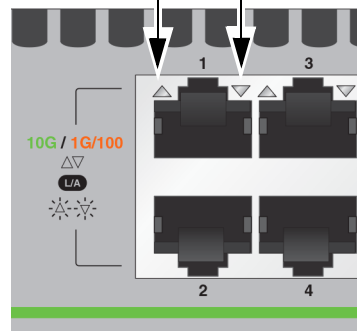

Figure 5. LEDs for the Twisted Pair Ports on the XS916MX Series Switch

The Port LEDs are described in Table 2.

Table 2. LEDs on the Twisted Pair Ports on the XS916MX Series Switch

LED	State	Description
L/A LED	Solid Green	A port has established a 10Gbps link to a network device.
	Flashing Green	A port is transmitting or receiving data at 10Gbps.
	Solid Amber	A port has established a 100 or 1000 Mbps link to a network device.
	Flashing Amber	A port is transmitting or receiving data at 100 or 1000 Mbps.
	Off	A port has not established a link with another network device or the LEDs are turned off. To turn on the LEDs, use the eco-friendly button.

LEDs for the SFP Slots

The LEDs for the SFP slots are located between the slots, as shown in Figure 6 on page 26. Each SFP slot has one LED. The left-hand LED is for the top slot and the right-hand LED is for the bottom slot.

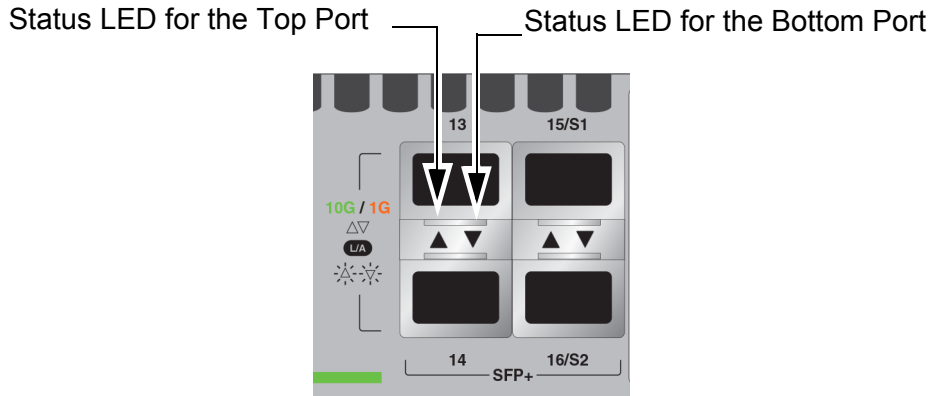

Figure 6. SFP Slot LEDs

The LEDs are described in Table 3.

Table 3. SFP Slot LEDs on the XS916MX Series Switch

LED	State	Description
L/A LED	Off	The slot is empty, the SFP transceiver has not established a link to a network device, or the LEDs are turned off. To turn on the LEDs, use the eco-friendly button.
	Solid Amber	The SFP/SFP+ transceiver has established a 1Gbps link to a network device.
	Flashing Amber	The SFP transceiver is receiving or transmitting data at 1Gbps.
	Solid Green	The SFP/SFP+ transceiver has established a 10Gbps link to a network device.
	Flashing Green	The SFP transceiver is receiving or transmitting data at 10Gbps.

LEDs for the Stacking Slots

Slots S1 and S2 are stacking slots for the VCStack feature. You can use the slots to build a virtual switch of two switches. For background information, refer to the *XS916MX Series Installation Guide for VCStack*. Table 4 on page 27 defines the LED states when the slots contain stacking transceivers.

Table 4. S1 and S2 Slot LEDs

LED	State	Description
Link/Activity	Off	The slot is empty, the stacking transceiver has not established a link to a network device, or the LEDs are turned off. To turn on the LEDs, use the eco-friendly button.
	Solid green	The stacking transceiver has established a link to another switch in the stack.
	Flashing green	The stacking transceiver is receiving or transmitting packets.

Switch ID LED

The Switch ID LED, shown in Figure 7, displays the ID number of the switch. A stand-alone switch has the ID number 0. Switches in a VCStack have the numbers 1 to 2. Chapter 5, “Powering On the Switch” on page 55 has the procedure for verifying and, if necessary, changing the ID number of the switch.

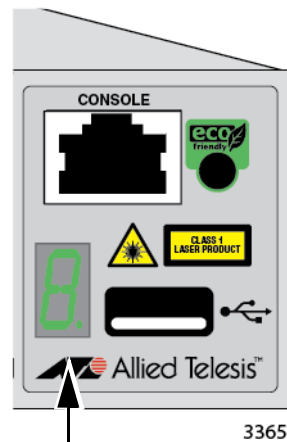

Switch ID LED

Figure 7. Switch ID LED

The states of the LED when the switch is not operating in the low power mode are shown in Figure 8 on page 28.

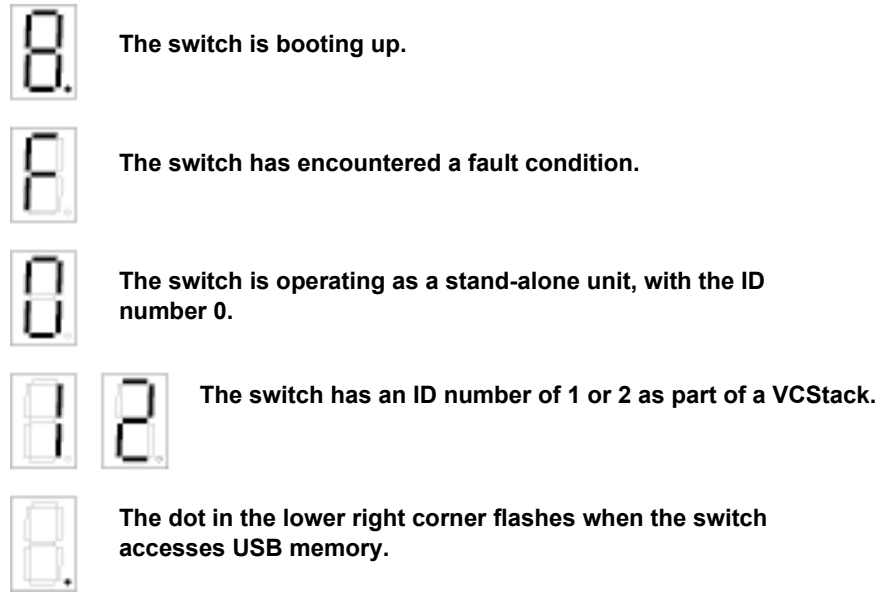

Figure 8. Switch ID LED Not in Low Power Mode

The switch displays the letter “F” for fault on the ID LED if it encounters one of the following problems:

- A cooling fan has failed.
- The internal temperature of the switch has exceeded the normal operating range and the switch may shut down.

Note

You can use the `SHOW SYSTEM ENVIRONMENT` command in the command line interface to identify the source of the problem.

The states of the LED when the switch is operating in the low power mode are shown in Figure 9.

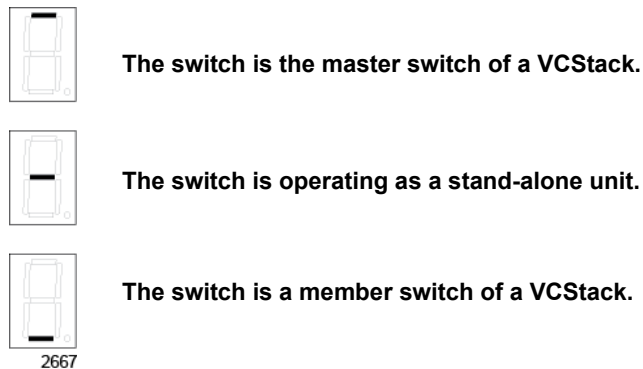

Figure 9. Switch ID LEDs in Low Power Mode

USB Port

The management panel has a USB port. You may use the port to store configuration files on flash drives and to restore configuration files to switches whose settings have been lost or corrupted, or to quickly configure replacement units. You may also use the port and flash drives to update the management firmware on the switches.

The port is USB2.0 compatible.

Console Port

The Console port is used to conduct management sessions with the switch to configure its features and parameter settings. This type of management uses serial RS-232 and is commonly referred to as local or out-of-band management because it is not conducted over your network. To perform local management, you must be at the location of the switch and must use the management cable included with the switch.

To establish a local management session with the switch, connect a terminal or a personal computer with a terminal emulation program to the Console port, which has an RJ-45 style (8P8C) connector, using the provided management cable. The cable has RJ-45 style (8P8C) and DB-9 (D-sub 9-pin) connectors.

The Console port is set to the following specifications:

- Default baud rate: 9600 bps (Range is 9600 to 115200 bps)
- Data bits: 8
- Parity: None
- Stop bits: 1
- Flow control: None

Note

These settings are for a DEC VT100 or ANSI terminal, or an equivalent terminal emulation program.

Power Supply

The XS916MX series switches come with one AC power supply. The back panels have one AC connector. The power supply is not field-replaceable; refer to “Technical Specifications” on page 71 for the input voltage range.



Warning

Power cord is used as a disconnection device. To de-energize equipment, disconnect the power cord. ⚡ E3

Note

The switches are powered on or off by connecting or disconnecting the power cords.

Chapter 2

Beginning the Installation

The chapter contains the following sections:

- “Reviewing Safety Precautions” on page 34
- “Choosing a Site for the Switch” on page 38
- “Unpacking the Switch” on page 39

Reviewing Safety Precautions

Review the following safety precautions before beginning the installation procedure.

Note

Safety statements that have the  symbol are translated into multiple languages in the *Translated Safety Statements* document at www.alliedtelesis.com/support.



Warning

Class 1 Laser product.  L1



Warning

Do not stare into the laser beam.  L2



Warning

Do not look directly at the fiber optic cable ends or inspect the cable ends with an optical lens.  L6



Warning

To prevent electric shock, do not remove the cover. No user-serviceable parts inside. This unit contains hazardous voltages and should only be opened by a trained and qualified technician. To avoid the possibility of electric shock, disconnect electric power to the product before connecting or disconnecting the LAN cables.  E1



Warning

Do not work on equipment or cables during periods of lightning activity.  E2



Warning

Power cord is used as a disconnection device. To de-energize equipment, disconnect the power cord.  E3

**Warning**

Class I Equipment. This equipment must be earthed. The power plug must be connected to a properly wired earth ground socket outlet. An improperly wired socket outlet could place hazardous voltages on accessible metal parts. ⚡ E4

Note

Pluggable Equipment. The socket outlet shall be installed near the equipment and shall be easily accessible. ⚡ E5

**Caution**

Air vents must not be blocked and must have free access to the room ambient air for cooling. ⚡ E6

**Warning**

Operating Temperatures. This product is designed for a maximum ambient temperature of 50 degrees C. ⚡ E57

Note

All Countries: Install product in accordance with local and National Electrical Codes. ⚡ E8

**Warning**

Only trained and qualified personnel are allowed to install or replace this equipment. ⚡ E14

**Caution**

Circuit Overloading: Consideration should be given to the connection of the equipment to the supply circuit and the effect that overloading of circuits might have on overcurrent protection and supply wiring. Appropriate consideration of equipment nameplate ratings should be used when addressing this concern. ⚡ E21



Caution

Risk of explosion if battery is replaced by an incorrect type. Replace only with the same or equivalent type recommended by the manufacturer. Dispose of used batteries according to the manufacturer's instructions. ⚡ E22



Warning

Mounting of the equipment in the rack should be such that a hazardous condition is not created due to uneven mechanical loading. ⚡ E25

Note

Use dedicated power circuits or power conditioners to supply reliable electrical power to the device. ⚡ E27



Caution

The chassis may be heavy and awkward to lift. Allied Telesis recommends that you get assistance when mounting the chassis in an equipment rack. ⚡ E28

Note

If installed in a closed or multi-unit rack assembly, the operating ambient temperature of the rack environment may be greater than the room ambient temperature. Therefore, consideration should be given to installing the equipment in an environment compatible with the manufacturer's maximum rated ambient temperature (T_{mra}). ⚡ E35



Caution

Installation of the equipment in a rack should be such that the amount of air flow required for safe operation of the equipment is not compromised. ⚡ E36



Warning

Reliable earthing of rack-mounted equipment should be maintained. Particular attention should be given to supply connections other than direct connections to the branch circuits (e.g., use of power strips). ⚡ E37

**Warning**

To reduce the risk of electric shock, the PoE ports on this product must not connect to cabling that is routed outside the building where this device is located. ⚡ E40

**Caution**

The unit does not contain serviceable components. Please return damaged units for servicing. ⚡ E42

**Warning**

When you remove an SFP module from this product, the case temperature of the SFP may exceed 40° C (158° F). Exercise caution when handling with unprotected hands. ⚡ E43

**Caution**

You have to reset the switch to disable the VCStack feature. Some network traffic may be lost if the device is already connected to a live network. ⚡ E75

**Caution**

Disabling the VCStack feature requires resetting the switch. If the switch is already connected to a live network, some network traffic may be lost. ⚡ E75A

**Warning**

Switches should not be stacked on top of one another on a table or desktop because that could present a personal safety hazard if you need to move or replace switches. ⚡ E76

**Warning**

A transceiver can be damaged by static electricity. Be sure to observe all standard electrostatic discharge (ESD) precautions, such as wearing an antistatic wrist strap, to avoid damaging the device. ⚡ E77

Choosing a Site for the Switch

Observe these requirements when planning the installation of the switch.

- If you plan to install the switch in an equipment rack, check to be sure that the rack is safely secured so that it will not tip over. Devices in a rack should be installed starting at the bottom, with the heavier devices near the bottom of the rack.
- If you plan to install the switch on a table, check to be sure that the table is level and stable.
- The power outlet should be located near the switch and be easily accessible.
- The site should allow for easy access to the ports on the front of the switch, so that you can easily connect and disconnect cables, and view the port LEDs.
- The site should allow for adequate air flow around the unit and through the cooling vents on the front and rear panels. (The ventilation direction in units that have a cooling fan is from front to back, with the fan on the back panel drawing the air out of the unit.)
- Do not install the switch in a wiring or utility box because the switch overheats and fails from inadequate airflow.
- The site should not expose the switch to moisture or water.
- The site should be a dust-free environment.
- The site should include dedicated power circuits or power conditioners to supply reliable electrical power to the network devices.
- The site should not expose the twisted pair cabling to sources of electrical noise, such as radio transmitters, broadband amplifiers, power lines, electric motors, and fluorescent fixtures.
- Switch ports are suitable for intra-building connections, or where non-exposed cabling is required.
- Do not place objects on top of the switch.



Warning

Switches should not be stacked on top of one another on a table or desktop because that could present a personal safety hazard if you need to move or replace switches. *See* E76

Unpacking the Switch

The XS916MX series switch comes with the components listed in Table 5.

Note

If any item is missing or damaged, contact your Allied Telesis sales representative for assistance.

Table 5. Components in the Shipping Box







Name		Item
AC power code		
Management cable, with RJ-45 (8P8C) and DB-9 (D-sub 9-pin) connectors.		
Power code retainer clip		
Rack mount bracket kit	2 X Bracket	
	2 X Handle	
	4 X M3x6mm screw	
	8 X M4x6mm screw	

Table 5. Components in the Shipping Box (Continued)

Name		Item
Wall mount bracket kit	4 X Bracket	
	16 M4x6mm screw	

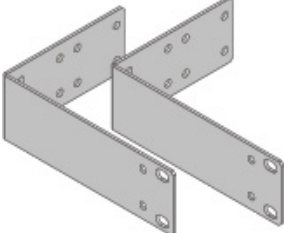
Note

You should retain the original packaging material in the event you need to return the unit to Allied Telesis.

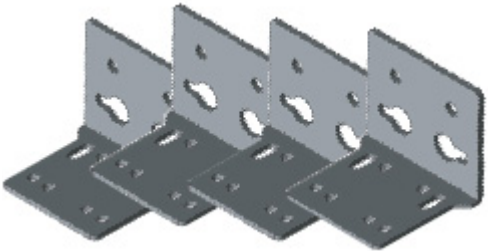
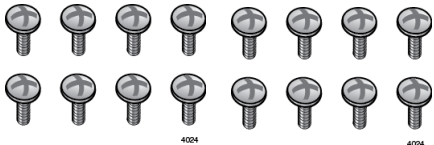
Chapter 3

Installing the Switch

The procedures in this chapter are:

- “Installing the Switch on a Table” on page 42
- “Installing the Switch in an Equipment Rack” on page 43
- “Installing the Switch on a Wall” on page 46

Installing the Switch on a Table

This section contains the procedure for installing the switch on a table or desk.

Note

The rubber feet on the bottom of the chassis should be left on for table installation.

**Warning**

Switches should not be stacked on top of one another on a table or desktop because that could present a personal safety hazard if you need to move or replace switches. *or* E76

To install the chassis on a table, perform the following procedure:

1. Review “Choosing a Site for the Switch” on page 38 to verify the suitability of the site for the switch.
2. Check to be sure that the table is strong enough to support the weight of the switch.
3. Lift the switch onto the table.
4. Go to Chapter 4, “Cabling the Networking Ports” on page 49 to connect the network cables.

Installing the Switch in an Equipment Rack

You can install one XS916MX series switch in a row of the equipment rack or two XS916MX series switches in one row of the equipment rack as shown in Figure 10.

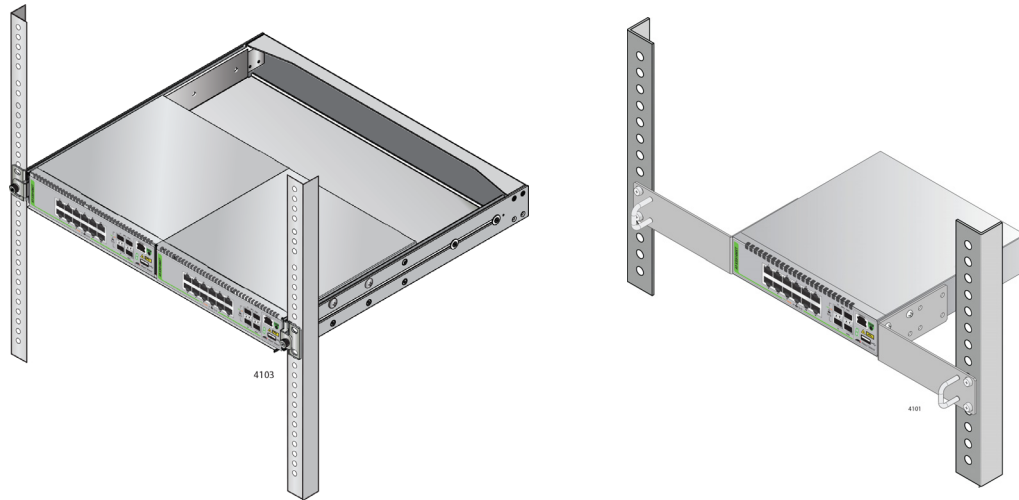

Figure 10. Rack Installation Options for the XS916MX Series Switch

Installing Two Switches in One Row

To install two switches in one row of the equipment rack, use the AT-BRKT-J15 rack mount kit.

Here are the guidelines:

- You must purchase the AT-BRKT-J15 rack mount kit separately.
- For the instructions using the AT-BRKT-J15 rack mount kit, see *The AT-x230-10GP, AT-AR3050S, AT-AR4050S, and XS916MX Series Switches Rack Mount Installation Guide*.

Installing a Switch in One Row

To install the switch in one row of the equipment rack, you need the following items:

- Rack mount bracket kit, which comes with the switch
- Flat-head screwdriver
- Cross-head screwdriver

Note

You must provide flat-head and cross-head screwdrivers.

To install the switch in one row of the equipment rack, perform the following procedures.



Caution

The chassis may be heavy and awkward to lift. Allied Telesis recommends that you get assistance when mounting the chassis in an equipment rack. ⚡ E28

1. Review “Choosing a Site for the Switch” on page 38 to verify the suitability of the site for the switch.
2. Place the unit upside down on a level, secure surface. See Figure 11.

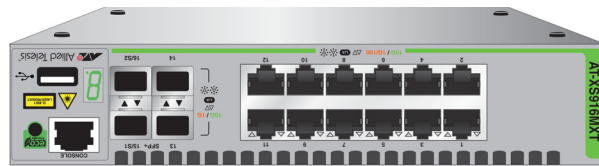

Figure 11. Turning the Switch Upside Down

3. Using a flat-head screwdriver, remove the rubber feet from the bottom of the switch. See Figure 12.

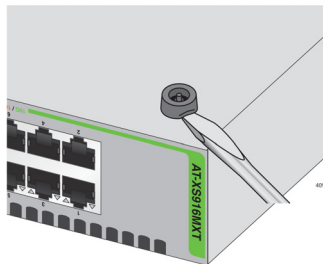

Figure 12. Removing the Rubber Feet

4. Turn the switch over.
5. Attach the handles to the brackets as shown in Figure 13.

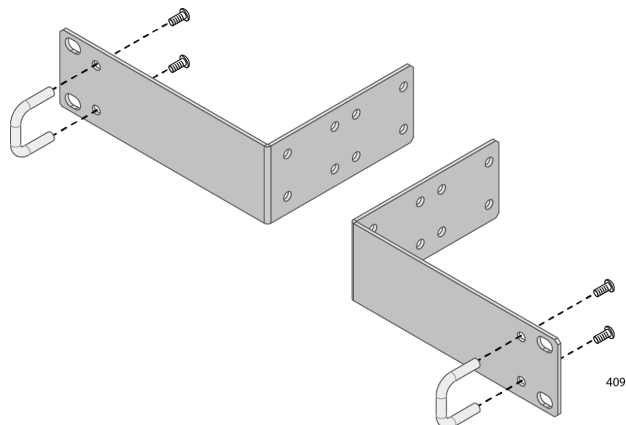

Figure 13. Attaching the Handles to the Brackets

6. Attach the two rack mount brackets to the sides of the switch with the eight bracket screws as shown in Figure 14.

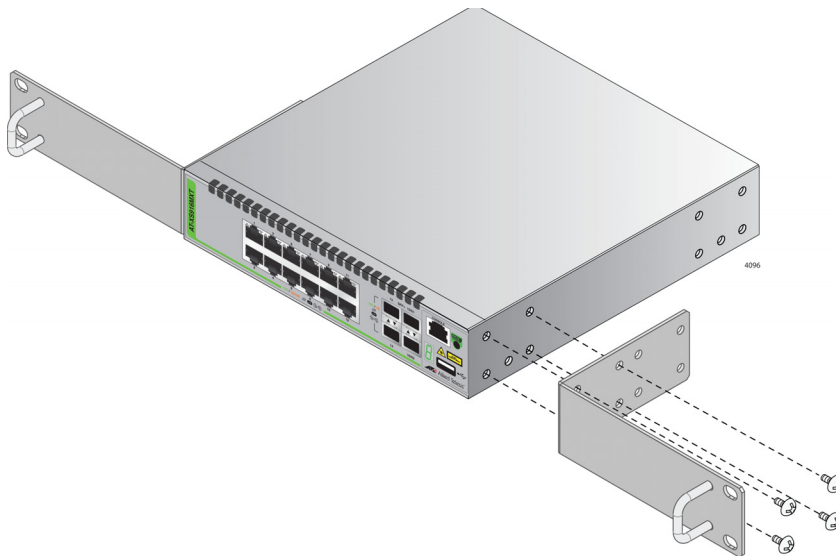

Figure 14. Installing the Brackets on the Switch

7. While another person holds the switch in the equipment rack, secure it with standard equipment rack screws as shown in Figure 15.

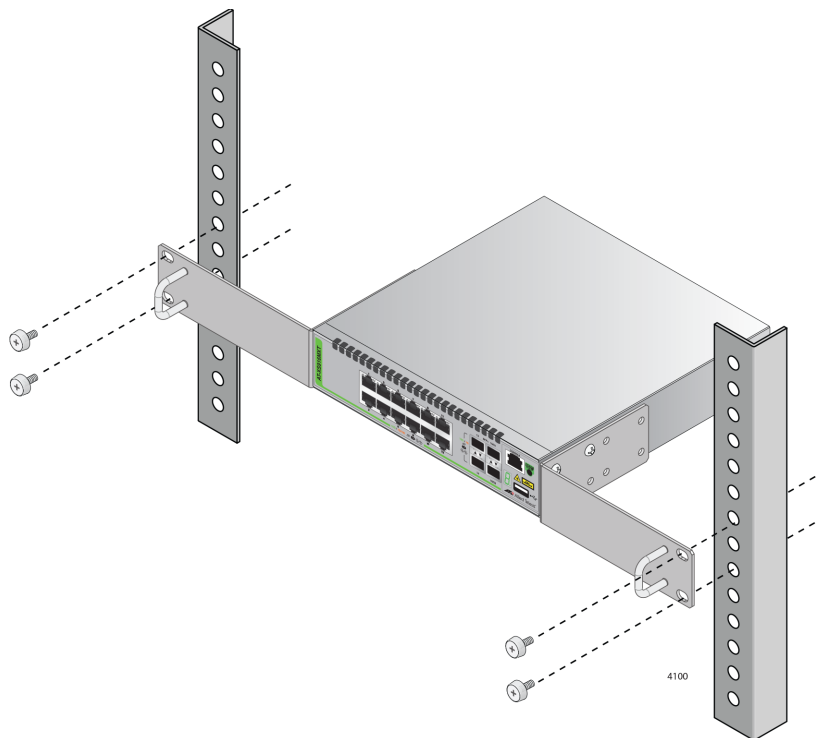

Figure 15. Mounting the Switch in an Equipment Rack

8. Go to Chapter 4, “Cabling the Networking Ports” on page 49, to connect the network cables to the ports on the switch.

Installing the Switch on a Wall

The XS916MX series switch must be mounted on the wall in portrait orientation with the front panel facing left or right. See Figure 16.



Figure 16. Positions of the XS916MX Series Switch on a Wall

What to Prepare for Wall Installation

You need the following items to install the switch on a wall:

- Wall mount bracket kit, which comes with the switch
- Flat-head screwdriver
- Cross-head screwdriver
- Drill

Note

You must provide flat-head and cross-head screwdrivers and a drill.

Installing the Switch on a Wall

To install the XS916MX series switch on a wall, perform the following procedure:

1. Review “Choosing a Site for the Switch” on page 38 before performing this procedure.
2. Place the unit upside down on a level, secure surface. See Figure 17.

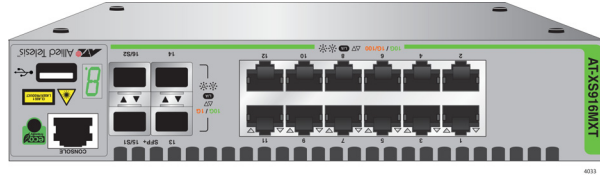

Figure 17. Turning the Switch Upside Down

3. Using a flat-head screwdriver, remove the rubber feet from the bottom of the switch. See Figure 18.

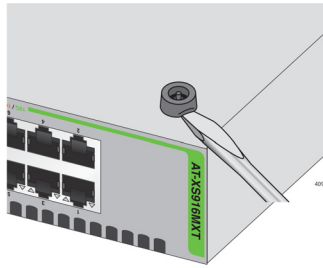

Figure 18. Removing the Rubber Feet

4. Attach each bracket to the switch using two screws, which should be installed diagonally as shown in Figure 19.

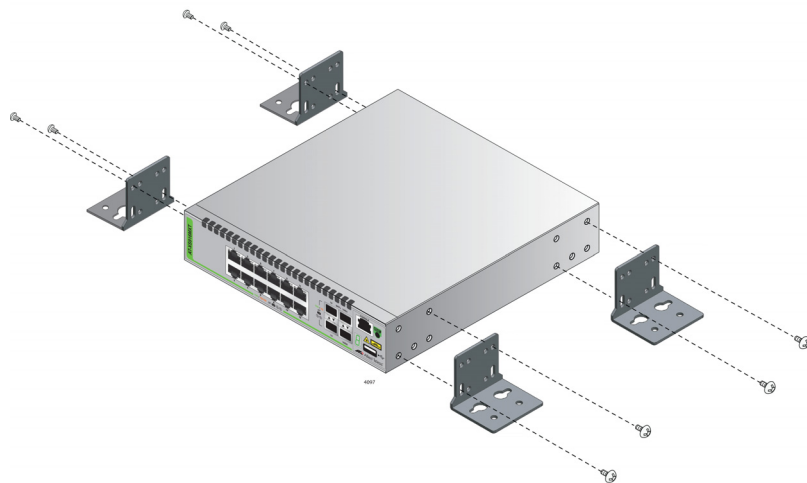

Figure 19. Attaching the Wall Brackets

5. Using a flat-head screwdriver, remove the rubber feet from the bottom of the switch. See Figure 20.

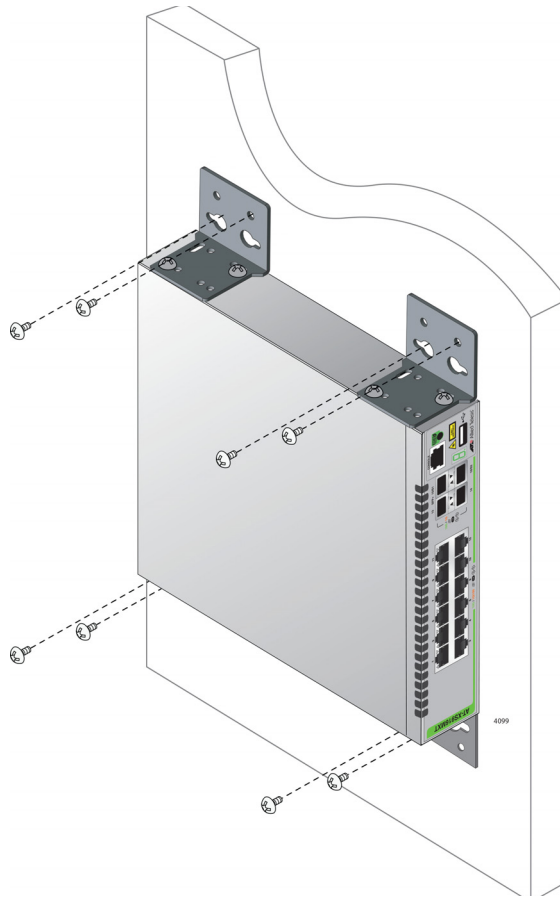

Figure 20. Installing the Switch on the Wall

Chapter 4

Cabling the Networking Ports

This chapter contains the following procedures:

- “Cabling the Twisted Pair Ports” on page 50
- “Installing SFP/SFP+ Transceivers” on page 51

Cabling the Twisted Pair Ports

Here are the guidelines to cabling the 100/1000/10000Base-T twisted pair ports:

- ❑ The cable specifications for the twisted pair ports are listed in Table 1 on page 21.
- ❑ The connectors on the cables should fit snugly into the ports, and the tabs should lock the connectors into place.
- ❑ The setting for the wiring configurations of the ports is auto-MDI/MDI-X. You cannot change the wiring configurations manually.
- ❑ The default speed setting for the ports is Auto-Negotiation. This setting is appropriate for ports connected to network devices that also support Auto-Negotiation.
- ❑ The default speed setting of Auto-Negotiation is not appropriate for ports connected to 100Base-TX network devices that do not support Auto-Negotiation and have fixed speeds. For those switch ports, you should disable Auto-Negotiation and set the port's speed manually to match the speeds of the network devices.
- ❑ The 100/1000/10000Base-T ports must be set to Auto-Negotiation, the default setting, to operate at 1000Mbps or 10Gbps.
- ❑ The default duplex mode setting for the ports is Auto-Negotiation. This setting is appropriate for ports connected to network devices that also support Auto-Negotiation for duplex modes.
- ❑ The default duplex mode setting of Auto-Negotiation is not appropriate for ports connected to network devices that do not support Auto-Negotiation and have a fixed duplex mode. You should disable Auto-Negotiation on those ports and set their duplex modes manually to avoid the possibility of duplex mode mismatches. A switch port using Auto-Negotiation defaults to half-duplex if it detects that the end node is not using Auto-Negotiation. This can result in a mismatch if the end node is operating at a fixed duplex mode of full-duplex.
- ❑ Do not attach cables to ports of static or LACP port trunks until after you have configured the trunks on the switch. Otherwise, the ports will form network loops that can adversely affect network performance.

Installing SFP/SFP+ Transceivers

This section contains guidelines and procedures for installing SFP/SFP+ transceivers.

Guidelines for SFP/SFP+ Transceivers

Here are general installation guidelines for SFP/SFP+ transceivers:

- ❑ SFP/SFP+ transceivers are hot-swappable. You may install them while the chassis is powered on.
- ❑ You should install a transceiver before connecting the fiber optic cable.
- ❑ Fiber optic transceivers are dust-sensitive. Always keep the plug in the optical bores when a fiber optic cable is not installed, or when you store the transceiver. When you do remove the plug, keep it for future use.
- ❑ Unnecessary removal and insertion of a transceiver can lead to premature failure.
- ❑ The S1 and S2 stacking slots can be used as SFP/SFP+ slots.



Warning

A transceiver can be damaged by static electricity. Be sure to observe all standard electrostatic discharge (ESD) precautions, such as wearing an antistatic wrist strap, to avoid damaging the device. *see* E77

Installing SFP/ SFP+ Transceivers

To install SFP/SFP+ transceivers, perform the following procedure:

1. Remove the dust plug from a transceiver slot on the switch. See Figure 21.

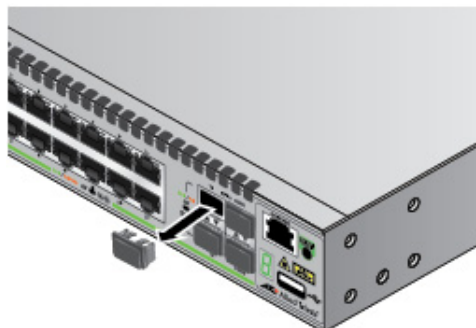

Figure 21. Removing the Dust Plug from an SFP/SFP+ Slot

2. Remove the transceiver from its shipping container and store the packaging material in a safe location.
3. Position the transceiver.

For a top slot, position the transceiver with the handle on top. For a bottom slot, position the transceiver with the handle beneath the module.

4. Slide the transceiver into the slot until it clicks into place. See Figure 22.

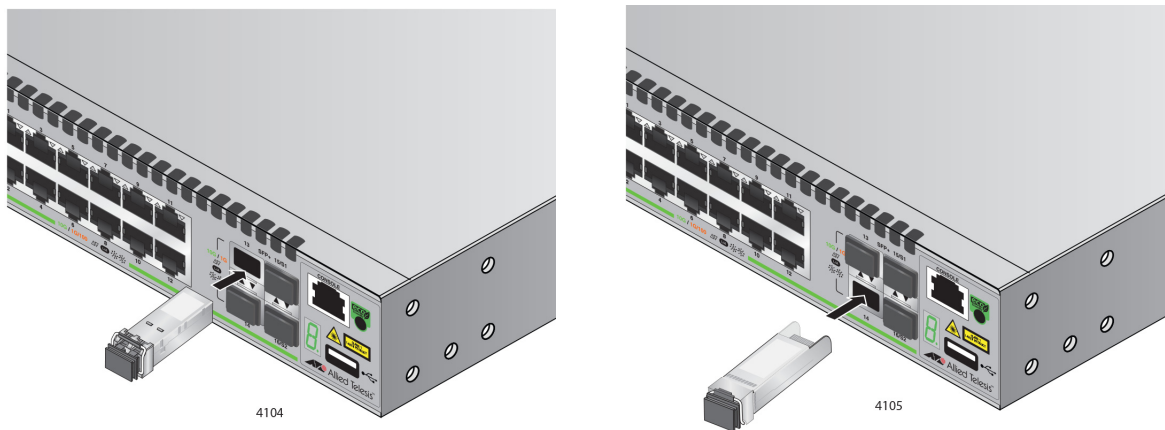

Figure 22. Installing an SFP/SFP+ Transceiver

Note

If you are ready to attach the fiber optic cable to the transceiver, continue with the next step. Otherwise, repeat Step 1 to Step 4 to install another SFP transceiver in the switch.

- Remove the dust cover from the transceiver, as shown in Figure 23.

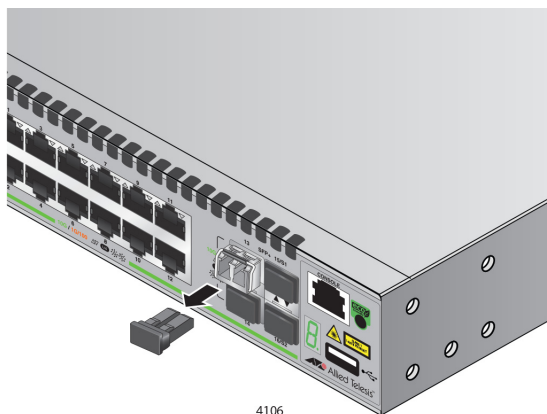

Figure 23. Removing the Dust Cover from an SFP Transceiver

- Verify the position of the handle on the SFP transceiver.

For a top slot, the handle is in the upright position, as shown in Figure 24. For a bottom slot, the handle should be in the down position.

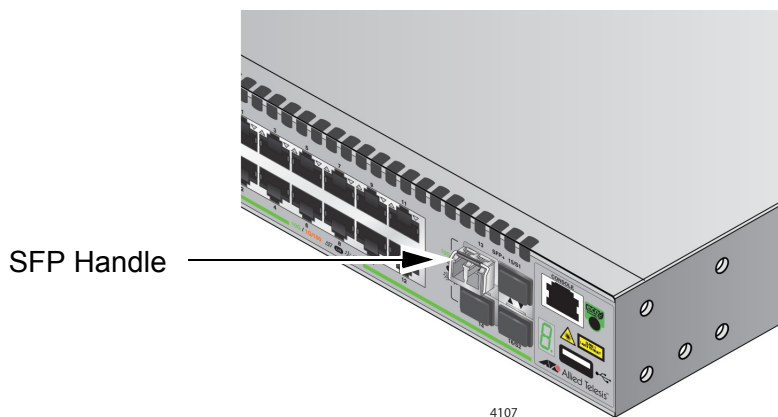

Figure 24. Positioning the SFP Handle in the Upright Position

7. Connect the fiber optic cable to the transceiver, as shown in Figure 25.

The connector on the cable should fit snugly into the port, and the tab should lock the connector into place.

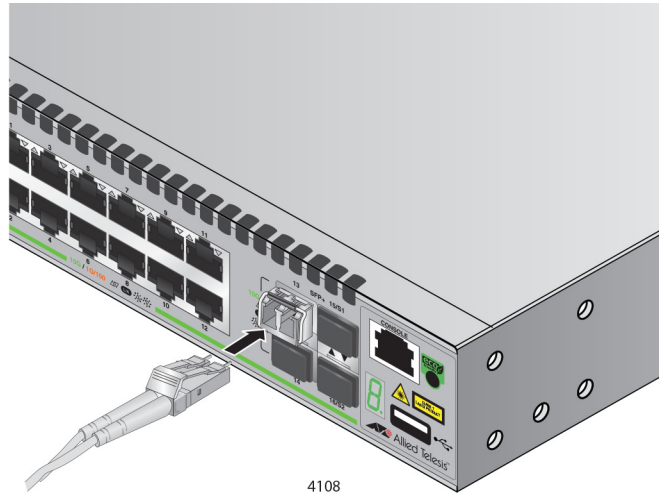

Figure 25. Connecting a Fiber Optic Cable to an SFP Transceiver

8. Repeat this procedure to install a second transceiver.
9. After installing the transceivers, go to Chapter 5, "Powering On the Switch" on page 55.

Chapter 5

Powering On the Switch

This chapter contains the following procedures:

- ❑ “Powering On the Switch” on page 56
- ❑ “Monitoring the Initialization Processes” on page 58
- ❑ “Configuring the Switch for Stand-alone Operations” on page 61
- ❑ “Specifying Ports in the Command Line Interface for Stand-alone Switches” on page 66

Powering On the Switch

Before powering on the switch, see “Power Specifications” on page 72 for the power specifications.

To install the power cord retaining clip and power on the switch, perform the following procedure:

1. Position the power cord retaining clip with the “u” part facing down, press in the sides, and insert the ends of the clip into the holes in the retaining bracket on the AC connector. See Figure 26.

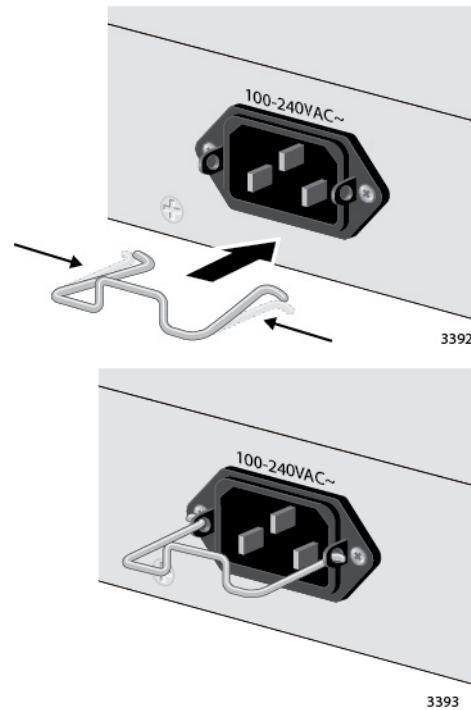

Figure 26. Installing the Retaining Clip

2. Raise the retaining clip. See Figure 27.

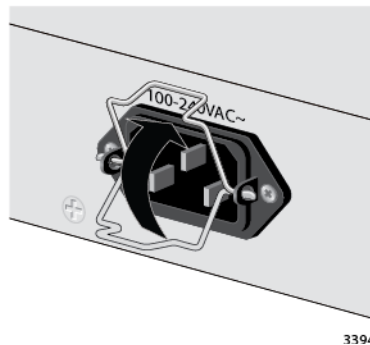

Figure 27. Raising the Retaining Clip

3. Connect the power cord to the connector. See Figure 28.

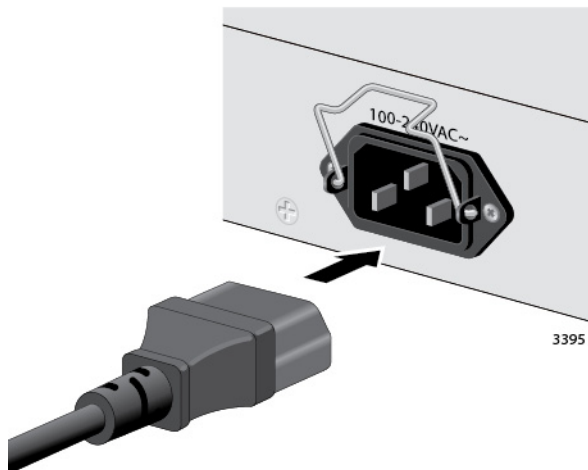

Figure 28. Plugging in the AC Power Cord

4. Lower the retaining clip to secure the power cord to the switch. See Figure 29.

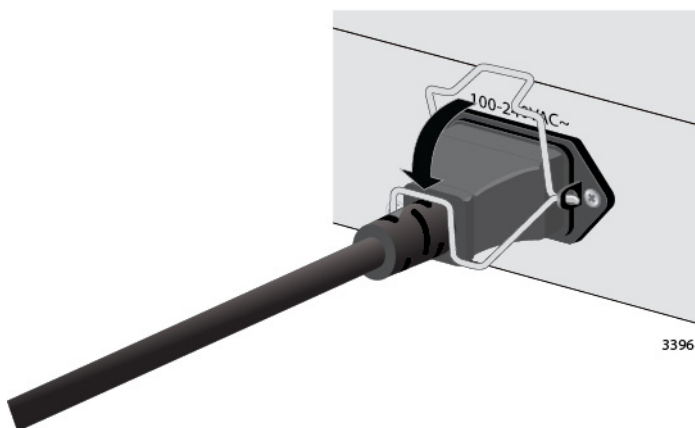

Figure 29. Lowering the Retaining Clip

5. Connect the other end of the power cord to an appropriate power source.



Warning

Power cord is used as a disconnection device. To de-energize equipment, disconnect the power cord. ⚡ E3

6. Go to “Monitoring the Initialization Processes” on page 58 or “Configuring the Switch for Stand-alone Operations” on page 61.

Monitoring the Initialization Processes

It takes about one and a half minutes for the switch to initialize its management software programs and features, and load the default configuration. You may monitor the progress of the initialization process by watching the switch ID LED. It displays the number “8” for the first minute and afterwards the number “0.”

You may also monitor the bootup sequence by connecting a terminal or computer that has a terminal emulator program to the Console port on the master switch. The messages are given in Figure 30 here to Figure 32 on page 60. The messages may differ slightly depending on whether your switch is a PoE or non-PoE model.

After the switch has initialized its management software, go to “Configuring the Switch for Stand-alone Operations” on page 61.

```

Bootloader 3.1.3-devel loaded
Press <Ctrl+B> for the Boot Menu

Reading filesystem...
Loading flash:xs900-main-20151028-4.rel...
Verifying release... OK
Booting...
Starting base/first...           [ OK ]
Mounting virtual filesystems...  [ OK ]

      _____
     /         \
    /           \
   /             \
  /               \
 /                 \
/                   \
/_____ \
 \         /
  \       /
   \     /
    \   /
     \ /
      /

Allied Telesis Inc.
AlliedWare Plus (TM) v0.0.0
Current release filename: xs900-main-20151028-4.rel
Built: wed oct 28 06:23:09 UTC 2015
Mounting static filesystems...   [ OK ]
Checking flash filesystem...     [ OK ]

```

Figure 30. Switch Initialization Messages

```

Mounting flash filesystem... [ OK ]
Checking for last gasp debug output... [ OK ]
Checking NVS filesystem... [ OK ]
Mounting NVS filesystem... [ OK ]
Starting base/arm_sysctl... [ OK ]
Starting base/dbus... [ OK ]
Starting base/syslog... [ OK ]
Starting base/loopback... [ OK ]
Starting base/poe_done... [ OK ]
Starting base/sysctl... [ OK ]
Starting base/portmapper... [ OK ]
Received event syslog.done
Starting base/reboot-stability... [ OK ]
Checking system reboot stability... mv: write error: No
space left on device
[ OK ]
Starting base/cron... [ OK ]
Starting base/apteryx... [ OK ]
Starting base/appmond... [ OK ]
Starting base/clockcheck... [ OK ]
Starting hardware/openhpi... [ OK ]
Starting hardware/timeout... [ OK ]
Starting base/inet... [ OK ]
Starting base/modules... [ OK ]
Received event modules.done
Received event board.inserted
Received event apteryx.done
Starting network/kermond... [ OK ]
Starting hardware/plugin... [ OK ]
Starting hardware/hardware-done... [ OK ]
Received event hardware.done
Starting network/startup... [ OK ]
Starting base/external-media... [ OK ]
Starting network/stackd... [ OK ]
Starting network/election.timeout... [ OK ]
Starting network/corosync... [ OK ]
Received event network.enabled

```

Figure 31. Switch Initialization Messages (Continued)

```
Initializing HA processes:  
atmfd, auth, cntrd, epsr, hostd, hsl, imi  
imiproxyd, lacp, lldpd, loopprot, mstp, nsm, ripd  
rmon, sflowd, udlld  
  
Received event network.initialized  
  
Assigning Active workload to HA processes:  
hsl, nsm, authd, epsrd, lacpd, lldpd, loopprot  
mstpd, rmond, sflowd, imi, imiproxyd  
  
Received event network.activated  
  
Loading default configuration  
..  
  
done!  
Received event network.configured  
  
awplus login:
```

Figure 32. Switch Initialization Messages (Continued)

Configuring the Switch for Stand-alone Operations

After the switch has initialized its management software, examine the switch ID LED on the front panel and do one of the following:

- ❑ If the LED is displaying “0,” the installation procedure is complete. The switch is now ready for network operations as a stand-alone unit. Refer to the *Software Reference for XS916MX Series Switches, AlliedWare Plus Operating System*, for instructions on how to configure the operating parameters.
- ❑ If the LED is not displaying “0” (for example, if is displaying the default number “1”), perform the following procedures to disable the VCStack feature.

You can disable the VCStack feature from a local management session of the switch using the Console port. To start a local management session, go to “Starting a Local Management Session,” next.



Caution

You have to reset the switch to disable the VCStack feature. Some network traffic may be lost if the device is already connected to a live network. ⚡ E75

Note

The initial management session of the switch must be from the Console port.

Starting a Local Management Session

This procedure requires a terminal or a terminal emulator program and the management cable that comes with the switch. To start a local management session on the switch, perform the following procedure:

1. Connect the RJ-45 connector on the management cable to the Console port on the front panel of the switch, as shown in Figure 33 on page 62.

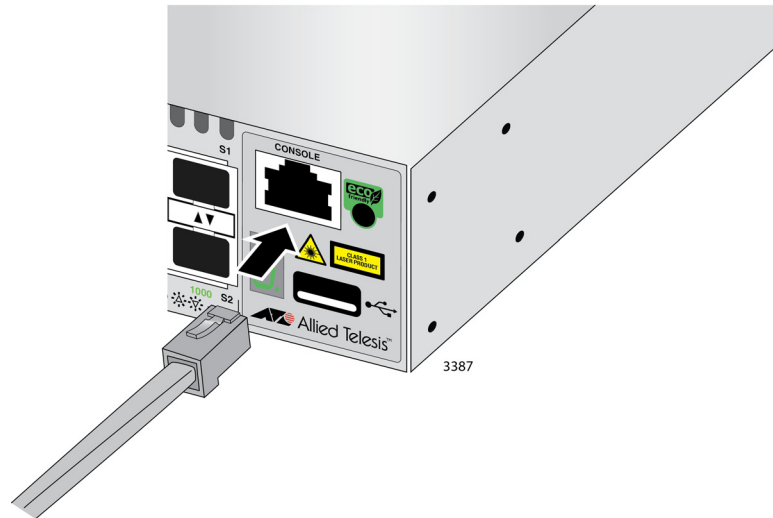

Figure 33. Connecting the Management Cable to the Console Port

2. Connect the other end of the cable to an RS-232 port on a terminal or PC with a terminal emulator program.
3. Configure the terminal or terminal emulator program as follows:
 - Baud rate: 9600 bps (The baud rate of the Console Port is adjustable from 1200 to 115200 bps. The default is 9600 bps.)
 - Data bits: 8
 - Parity: None
 - Stop bits: 1
 - Flow control: None

Note

The port settings are for a DEC VT100 or ANSI terminal, or an equivalent terminal emulator program.

4. Press Enter.
You are prompted for a user name and password.
5. When prompted for a user name, go to “Disabling VCStack” on page 63.

Disabling VCStack

To disable the VCStack feature to use the switch as stand-alone unit, perform the following procedure:



Caution

Disabling the VCStack feature requires resetting the switch. If the switch is already connected to a live network, some network traffic may be lost. ⚡ E75A

1. When prompted, enter a user name and password to log on the switch.

If this is the initial management session of the switch, enter “manager” as the user name and “friend” as the password. The user name and password are case sensitive.

The local management session starts when the User Exec mode prompt, shown in Figure 34, is displayed.

```
awplus>
```

Figure 34. User Exec Mode Prompt

Note

The User Exec mode is the first level in the command mode interface. For complete information on the modes and commands, refer to the *Software Reference for XS916MX Series Switches, AlliedWare Plus Operating System* from www.alliedtelesis.com/support.

2. Enter the SHOW STACK command to display the status of the VCStack feature. Figure 35 is an example of the command.

```
awplus> show stack
Virtual Chassis Stacking summary information
ID      Pending ID  MAC address      Priority  Status  Role
1       -           0015:774f:ed30  128     Ready   Active Master
Operational Status           Standalone Unit
Stack MAC address 0015:774f:ed30
awplus(config)#
```

Figure 35. SHOW STACK Command

3. Review the following items:
 - ❑ If the Operational Status is “Stacking Hardware Disabled,” the VCStack feature is already disabled on the switch. The switch is ready for operations as a stand-alone switch in your network. No further installation steps are required.
 - ❑ If the Operational Status is “Standalone Unit,” as shown in Figure 35 on page 63, the VCStack feature is active on the unit. You must disable it by performing the steps in the rest of this procedure before you can use the SFP+ stacking slots with regular SFP or SFP+ transceivers. The reason the status says “standalone” is because the switch considers itself a stack of one switch.
4. Move to the Global Configuration mode by entering the ENABLE and CONFIGURE TERMINAL commands, as shown in Figure 36.

```
awplus> enable
awplus# configure terminal
Enter configuration commands, one per line. End with CNTL/Z
awplus(config)#
```

Figure 36. Moving to the Global Configuration Mode

5. To disable the VCStack feature on the switch, enter the NO STACK ENABLE command, which has this format:

```
no stack id enable
```

The ID parameter is the ID number of the switch, displayed on the ID LED. Replace the parameter with whatever number is on the ID LED. For example, if the ID number of the switch is 1, the default value, enter the command as follows:

```
awplus(config)# no stack 1 enable
```

This confirmation prompt in Figure 37 is displayed.

```
Warning; This will disable the stacking hardware on member-1.
Are you sure you want to continue? (y/n):
```

Figure 37. Confirmation Prompt for the NO STACK ENABLE Command

6. Type Y to disable VCStack on the switch or N to cancel the procedure.

7. Enter the EXIT command to return to the Privileged Exec mode, as shown in Figure 38.

```
awplus(config)# exit
awplus#
```

Figure 38. Returning to the Privileged Exec Mode

8. Enter the WRITE command to save your change in the configuration file. The switch displays the confirmation prompt in Figure 39.

```
awplus# write
Building configuration ...
[OK]
awplus#
```

Figure 39. Saving the Changes with the WRITE Command

9. Enter the REBOOT command to reboot the switch.
10. At the confirmation prompt, type “Y” for yes.
11. Wait for the switch to initialize its management software and afterwards examine the Switch ID LED.

If the ID number is “0,” the switch is ready for normal network operations as a stand-alone unit. Refer to the *Software Reference for XS916MX Series Switches, AlliedWare Plus Operating System*, for instructions on how to configure the operating parameters. If the number is not “0,” repeat this procedure.

Specifying Ports in the Command Line Interface for Stand-alone Switches

The command line interface in the management software on the switch has a parameter that you use to specify the individual ports. The parameter is the PORT parameter, and Figure 40 shows its format.

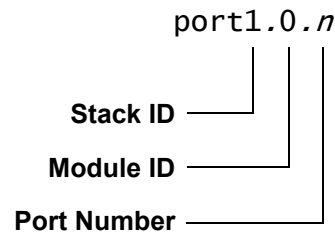

Figure 40. PORT Parameter in the Command Line Interface

The first number is the switch's ID number. The ID number for stand-alone switches is not the value 0 displayed on the Switch ID LEDs. Rather, it is 1. Be sure to enter 1, not 0, as the ID number in the PORT parameter when configuring ports on stand-alone switches.

The module ID value is used with multi-module products. This value does not apply to the XS916MX Series switches and should always be 0.

The third value is a port number on the switch. You may specify only one port number in a PORT parameter, but you may specify more than one PORT parameter in many commands where the parameter is supported.

Here is an example of the PORT parameter on a stand-alone switch. It uses the INTERFACE command to enter the Port Interface mode for ports 15 and 17:

```
awplus> enable
awplus# configure terminal
awplus(config)# interface port1.0.15,port1.0.17
```

For instructions on the command line interface and the PORT parameter, refer to the *Software Reference for XS916MX Series Switches, AlliedWare Plus Operating System*.

Chapter 6

Troubleshooting

This chapter contains suggestions on how to troubleshoot the switch if a problem occurs.

Note

For further assistance, please contact Allied Telesis Technical Support at www.alliedtelesis.com/support.

Problem 1: The Switch ID LED on the front of the switch is off.

Solutions: The unit is not receiving power. Try the following:

- Verify that the power cord is securely connected to the power source and to the AC connector on the back panel of the switch.
- Verify that the power outlet has power by connecting another device to it.
- Try connecting the unit to another power source.
- Try a different power cord.
- Verify that the voltage from the power source is within the required levels for your region.

Problem 2: All of the port LEDs are off even though the ports are connected to active network devices.

Solution: The switch may be operating in the low power mode. To toggle on the LEDs, press the eco-friendly button on the front panel of the switch. You may also toggle the LEDs off and on with the ECOFRIENDLY LED and NO ECOFRIENDLY LED commands in the command line interface.

Problem 3: A twisted pair port on the switch is connected to a network device, but the port's LINK/ACT LED is off.

Solutions: The port is unable to establish a link to a network device. Try the following:

- Verify that the port is connected to the correct twisted pair cable. This is to eliminate the possibility that the port is connected to the wrong network device.
- Verify that the network device connected to the twisted pair port is powered on and is operating properly.

- ❑ Try connecting another network device to the twisted pair port with a different cable. If the twisted pair port is able to establish a link, then the problem is with the cable or the other network device.
- ❑ Verify that the twisted pair cable does not exceed 100 meters (328 feet).
- ❑ Verify that you are using the appropriate category of twisted pair cable. The cable types are listed in Table 1 on page 21 for the 10/100/1000Base-T ports.

Note

A 1000Base connection may require five to ten seconds to establish a link.

Problem 4: The LINK/ACT LED for an SFP transceiver is off.

Solutions: The fiber optic port on the transceiver is unable to establish a link to a network device. Try the following:

- ❑ Verify that the remote network device connected to the fiber optic port is operating properly.
- ❑ Verify that the fiber optic cable is securely connected to the port on the SFP module and to the port on the remote network device.
- ❑ Check that the transceiver is fully inserted in the slot.
- ❑ Check to be sure that the transceiver is not installed in slot S1 or S2 in the switch.
- ❑ Verify that the operating specifications of the fiber optic ports on the transceiver and remote network device are compatible.
- ❑ Verify that the correct type of fiber optic cabling is being used.
- ❑ Verify that the port is connected to the correct fiber optic cable. This is to eliminate the possibility that the port is connected to the wrong remote network device.
- ❑ Try connecting another network device to the fiber optic port using a different cable. If the port is able to establish a link, then the problem is with the cable or with the other network device.
- ❑ Use the switch's management software to verify that the port is enabled.
- ❑ If the remote network device is a managed device, use its management firmware to determine whether its port is enabled.
- ❑ Test the attenuation of both directions on the fiber optic cable with a fiber optic tester to determine whether the optical signal is too weak (sensitivity) or too strong (maximum input power).

Problem 5: Network performance between a twisted pair port on the switch and a network device is slow.

Solution: There might be a duplex mode mismatch between the port and the network device. This can occur when a twisted pair port using Auto-Negotiation is connected to a remote device that has a fixed speed of 10 or 100 Mbps and a fixed duplex mode of full-duplex. If this is the cause of the problem, adjust the duplex mode of the port on the network device or switch so that both ports are using the same duplex mode. You can use either the LEDs or management software on the switch to determine the duplex mode settings of the ports. The LEDs are described in Table 2 on page 25.

Problem 6: The switch functions intermittently.

Solutions: Check the system hardware status through the management software:

- ❑ Use the SHOW SYSTEM ENVIRONMENT command in the Privileged Exec mode to verify that the input voltage from the power source to the switch is stable and within the approved operating range. The unit will shut down if the input voltage fluctuates above or below the approved operating range.
- ❑ Use the SHOW SYSTEM ENVIRONMENT command in the Privileged Exec mode to verify that the fan is operating correctly.
- ❑ Verify that the location of the switch allows for adequate airflow. The unit will shut down if it is in danger of overheating.

Problem 7: The Switch ID LED on the front of the switch is flashing the letter “F.”

Solutions: One or more of the following problems has occurred:

- ❑ A cooling fan has failed.
- ❑ The input voltage on the power supply is outside the normal operating range.
- ❑ The internal temperature of the switch has exceeded the normal operating range, and the switch may shut down.

Contact your Allied Telesis sales representative for assistance.

Problem 8: The AT-GS924MPX or AT-GS948MPX Switch is not providing power to a PoE device.

Solutions: Try the following:

- ❑ Review the PD’s documentation to confirm that the device supports Alternative B of the IEEE 802.3at standard. Alternative B is one of two modes that define the connector pins that deliver the power from the port on the line card to the PD. In Alternative B, the power

is carried on pins 4, 5, 7, and 8 on the RJ-45 port, the same pins that carry the network traffic. The other mode, Alternative A, defines pins 1, 2, 3, and 6 as the power carriers. The AT-GS924MPX and AT-GS948MPX Switches do not support Alternative A. Most powered devices are designed to accept power by either mode, but some legacy devices may only support one mode. This can be verified by reviewing the device's documentation or data sheet. Legacy devices that only support Alternative A will not work with the switches.

- ❑ Check that the device's power requirements do not exceed 30 W. This can be verified by reviewing the device's documentation or data sheet.
- ❑ Verify that you are using the appropriate category of twisted-pair cable by referring to Table 1 on page 21.
- ❑ Use the management software on the switch to determine whether PoE is enabled on the port. The default setting for PoE is enabled.
- ❑ Use the management software on the switch to determine whether the PoE power setting for the port has been reduced to a value below the power requirements of the device.
- ❑ Try connecting the device to a different port on the switch.

Appendix A

Technical Specifications

This appendix contains the following sections:

- "Physical Specifications"
- "Environmental Specifications" on page 72
- "Power Specifications" on page 72
- "Certifications" on page 73
- "RJ-45 Twisted Pair Port Pinouts" on page 74
- "RJ-45 Style Serial Console Port Pinouts" on page 75

Physical Specifications

Dimensions (H x W x D)

Table 6. Product Dimensions

AT-XS916MXT	4.3 cm x 21 cm x 32.3 cm (1.7 in. x 8.3 in. x 12.7 in.)
AT-XS916MXS	4.3 cm x 21 cm x 32.3 cm (1.7 in. x 8.3 in. x 12.7 in.)

Weights

Table 7. Product Weights

AT-XS916MXT	2.8 kg (6.1 lb.)
AT-XS916MXS	2.7 kg (5.9 lb.)

Ventilation

Table 8. Ventilation Requirements

Recommended Minimum Ventilation on All Sides	10 cm (4.0 in)
--	----------------

Environmental Specifications

Table 9. Environmental Specifications

Operating Ambient Temperature	0° C to 50° C (32° F to 122° F)
Storage Temperature	-25° C to 70° C (-13° F to 158° F)
Operating Humidity	5% to 90% noncondensing
Storage Humidity	5% to 95% noncondensing
Maximum Operating Altitude	3,000 m (6,562 ft)

Power Specifications

Input Voltages

Table 10. Input Voltages

AT-XS916MXT	Voltage: 100-240 VAC, 1.0A Frequency: 47-63 Hz
AT-XS916MXS	Voltage: 100-240 VAC, 1.0A Frequency: 47-63 Hz

Maximum Power Consumption

Table 11. Maximum Power Consumption

AT-XS916MXT	78 watts
AT-XS916MXS with 60 watts power supply	51 watts
AT-XS916MXS with 100 watts power supply	53 watts

Heat Dissipation (British Thermal Units/hour)

Table 12. Heat Dissipation

AT-XS916MXT	270 BTU/h
AT-XS916MXS with 60 watts power supply	170 BTU/h
AT-XS916MXS with 100 watts power supply	180 BTU/h

Certifications

Table 13. Product Certifications

RFI Emissions	FCC Class A, EN55022 Class A, EN61000-3-2, EN61000-3-3, VCCI Class A, RCM
EMC (Immunity)	EN55024
Electrical and Laser Safety	UL 60950-1 (cUL _{US}), CSA-C22 No. 60950-1 (cUL _{US}), EN60950-1 (TUV), EN60825-1 (TUV)

RJ-45 Twisted Pair Port Pinouts

Figure 41 illustrates the pin layout of the RJ-45 connectors and ports.

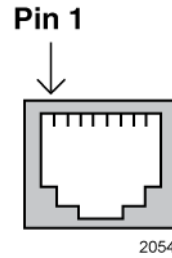

Figure 41. RJ-45 Socket Pin Layout (Front View)

Table 14 lists the pin signals for 10 and 100 Mbps.

Table 14. Pin Signals for 10 and 100 Mbps

Pin	MDI Signal	MDI-X Signal
1	TX+	RX+
2	TX-	RX-
3	RX+	TX+
4	Not used	Not used
5	Not used	Not used
6	RX-	TX-
7	Not used	Not used
8	Not used	Not used

The pin signals for a port operating at 1000 Mbps are shown in Table 15.

Table 15. Pin Signals for 1000 Mbps

Pinout	Pair
1	Pair 1 +
2	Pair 1 -
3	Pair 2 +
4	Pair 3 +

Table 15. Pin Signals for 1000 Mbps (Continued)

Pinout	Pair
5	Pair 3 -
6	Pair 2 -
7	Pair 4 +
8	Pair 4 -

RJ-45 Style Serial Console Port Pinouts

The pin signals of the RJ-45 style serial Console port are listed in Table 16.

Table 16. RJ-45 Style Serial Console Port Pin Signals

Pin	Signal
1	Looped to pin 8
2	Looped to pin 7
3	Transmit Data
4	Ground
5	Ground
6	Receive Data
7	Looped to pin 2
8	Looped to pin 1

